

JVC

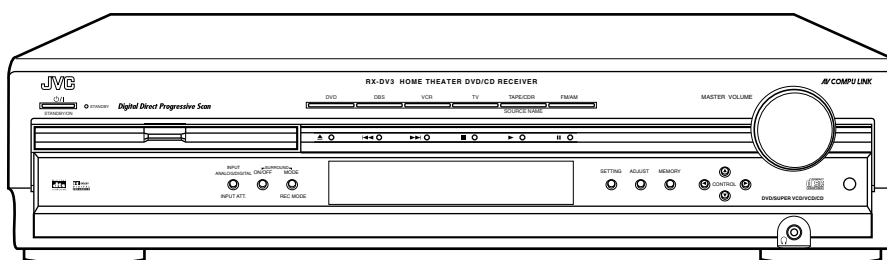

HOME THEATER DVD/CD RECEIVER

RX-DV3SL

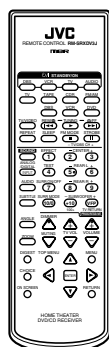

AV COMPU LINK
Digital Direct Progressive Scan



INSTRUCTIONS

For Customer Use:

Enter below the Model No. and Serial No. which are located either on the rear, bottom or side of the cabinet. Retain this information for future reference.

Model No. _____

Serial No. _____

LVT0875-001A

[J]

Warnings, Cautions and Others

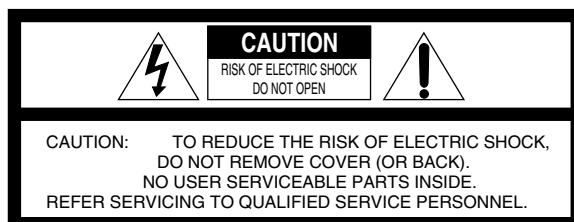

The lightning flash with arrowhead symbol, within an equilateral triangle is intended to alert the user to the presence of uninsulated "dangerous voltage" within the product's enclosure that may be of sufficient magnitude to constitute a risk of electric shock to persons.



The exclamation point within an equilateral triangle is intended to alert the user to the presence of important operating and maintenance (servicing) instructions in the literature accompanying the appliance.

WARNING: TO REDUCE THE RISK OF FIRE OR ELECTRIC SHOCK, DO NOT EXPOSE THIS APPLIANCE TO RAIN OR MOISTURE.

For U.S.A.

This equipment has been tested and found to comply with the limits for a Class B digital device, pursuant to part 15 of the FCC Rules. These limits are designed to provide reasonable protection against harmful interference in a residential installation.

This equipment generates, uses and can radiate radio frequency energy and, if not installed and used in accordance with the instructions, may cause harmful interference to radio communications. However, there is no guarantee that interference will not occur in a particular installation. If this equipment does cause harmful interference to radio or television reception, which can be determined by turning the equipment off and on, the user is encouraged to try to correct the interference by one or more of the following measures:

Reorient or relocate the receiving antenna.

Increase the separation between the equipment and receiver.

Connect the equipment into an outlet on a circuit different from that to which the receiver is connected.

Consult the dealer or an experienced radio/TV technician for help.

Note to CATV system installer:

This reminder is provided to call the CATV system installer's attention to Section 820-40 of the NEC which provides guidelines for proper grounding and, in particular, specifies that the cable ground shall be connected to the grounding system of the building, as close to the point of cable entry as practical.

CAUTION

To reduce the risk of electrical shocks, fire, etc.:

1. Do not remove screws, covers or cabinet.
2. Do not expose this appliance to rain or moisture.

Caution — /STANDBY/ON button!

Disconnect the mains plug to shut the power off completely.

The /STANDBY/ON button in any position does not disconnect the mains line.

The STANDBY/ON can be remote controlled.

IMPORTANT FOR LASER PRODUCTS

1. CLASS 1 LASER PRODUCT
 2. **CAUTION:** Visible and invisible laser radiation when open and interlock failed or defeated. Avoid direct exposure to beam.
 3. **CAUTION:** Do not open the top cover. There are no user serviceable parts inside the Unit; leave all servicing to qualified service personnel.
-

Table of Contents

| | | | |
|--|-----------|--|-----------|
| Parts Identification | 2 | Creating Realistic Sound Fields | 25 |
| Front Panel | 2 | Activating Surround Mode | 27 |
| Remote Control | 3 | Selecting Surround Modes | 27 |
| Getting Started | 4 | Adjusting Surround Mode Using Remote Control | 28 |
| Before Installation | 4 | DVD Player Operations | 29 |
| Checking the Supplied Accessories | 4 | Disc Information | 29 |
| Putting Batteries in the Remote Control | 4 | Using the On-screen Bar | 31 |
| Connecting the FM and AM Antennas | 5 | Basic Operation through the On-screen Bar | 32 |
| Connecting the Speakers | 6 | Changing the Time Indication | 32 |
| Connecting Audio/Video Components | 7 | Locating a Desired Scene from the Disc Menu | 33 |
| ■ About connecting cords | 7 | Selecting a View Angle—ANGLE | 34 |
| ■ TV connection | 8 | Changing the Languages—SUBTITLE and AUDIO | 35 |
| ■ VCR connection | 9 | Playing from a Specified Position on a Disc | 37 |
| ■ DBS connection | 9 | ■ Locating a desired chapter—Chapter Search | 37 |
| ■ TAPE/CDR connection | 10 | ■ Locating a desired position—Time Search | 37 |
| ■ Digital connection | 10 | ■ Locating a desired scene—DIGEST | 38 |
| Basic Operations | 11 | Special Picture Playback | 39 |
| 1 Turn On the Power | 11 | ■ Frame-by-frame playback | 39 |
| 2 Select the Source to Play | 11 | ■ Showing continuous still pictures—STROBE | 39 |
| 3 Adjust the Volume | 11 | ■ Playing back in slow-motion | 39 |
| Turning Off the Sounds Temporarily | 12 | ■ Zooming in—ZOOM | 39 |
| Turning Off the Power with the Sleep Timer | 12 | ■ Changing the VFP setting—VFP | 40 |
| Changing the Display Brightness | 12 | Program Playback and Random Playback | 41 |
| Changing the Source Name | 12 | Repeat Playback | 42 |
| Selecting the Analog or Digital Input Mode | 13 | MP3 Disc Playback | 43 |
| Changing the Digital Input Mode Manually | 13 | Basic Operations | 43 |
| Attenuating the Input Signal | 14 | Operations through the MP3 Control Screen | 44 |
| Changing the Scanning Mode | 14 | Repeat Playback | 44 |
| Activating the Recording Mode | 14 | JPEG Disc Playback | 45 |
| Basic DVD Player Operations | 15 | Slide-show Playback | 45 |
| 1 Open the Disc Tray | 15 | Operations through the JPEG Control Screen | 46 |
| 2 Load a Disc | 15 | Repeat Playback | 46 |
| 3 Start Playback | 15 | Choice Menu Operations | 47 |
| 4 Adjust the Volume | 16 | Operation Buttons | 47 |
| 5 Activate Realistic Sound Field | 16 | Configuration of Choice Menu | 47 |
| 6 Select Surround Mode | 16 | Operating Procedure | 48 |
| 7 Stop Playback | 16 | ■ LANGUAGE menu | 49 |
| 8 Turn Off the Power (into Standby) | 16 | ■ PICTURE menu | 49 |
| Tuner Operations | 17 | ■ AUDIO menu | 50 |
| Tuning into Stations Manually | 17 | ■ SPK. SETTING menu | 51 |
| Using Preset Tuning | 17 | ■ OTHERS menu | 52 |
| Selecting the FM Reception Mode | 18 | Restricting Playback by Parental Lock | 53 |
| Basic Settings | 19 | Glossary for DVD Player | 56 |
| Operation Buttons | 19 | AV COMPU LINK Remote Control System | 57 |
| Operating Procedure | 19 | Operating JVC's Audio/Video Components | 59 |
| ■ Speakers information—"SUBWFR," "FRNT SP," | | Operating Audio Components | 59 |
| "CNTR SP;" and "REAR SP" | 20 | Operating Video Components | 60 |
| ■ Speakers distance | | Operating Other Manufacturers' Equipment | 61 |
| —"FRNT D," "CNTR D," and "REAR D" | 20 | Changing the Preset Signal Codes | 61 |
| ■ Crossover frequency—"CROSS" | 21 | Maintenance | 64 |
| ■ Low frequency effect attenuator—"LFE" | 21 | Troubleshooting | 65 |
| ■ Dynamic range compression—"D.COMP" | 21 | Specifications | 68 |
| ■ Digital input (DIGITAL IN) terminals—"DGT" | 21 | | |
| ■ Auto surround—"AUTO SR" | 22 | | |
| ■ Video output mode—"VOUT" | 22 | | |
| Sound Adjustments | 23 | | |
| Operation Buttons | 23 | | |
| Operating Procedure | 23 | | |
| ■ Front speakers output balance—"BAL" | 24 | | |
| ■ Tone—"BASS" and "TREBLE" | 24 | | |
| ■ Speaker output level—"SUBWFR," "CENTER," | | | |
| "REAR L," and "REAR R" | 24 | | |
| ■ DAP effect level—"EFFECT" | 24 | | |

Parts Identification

Front Panel

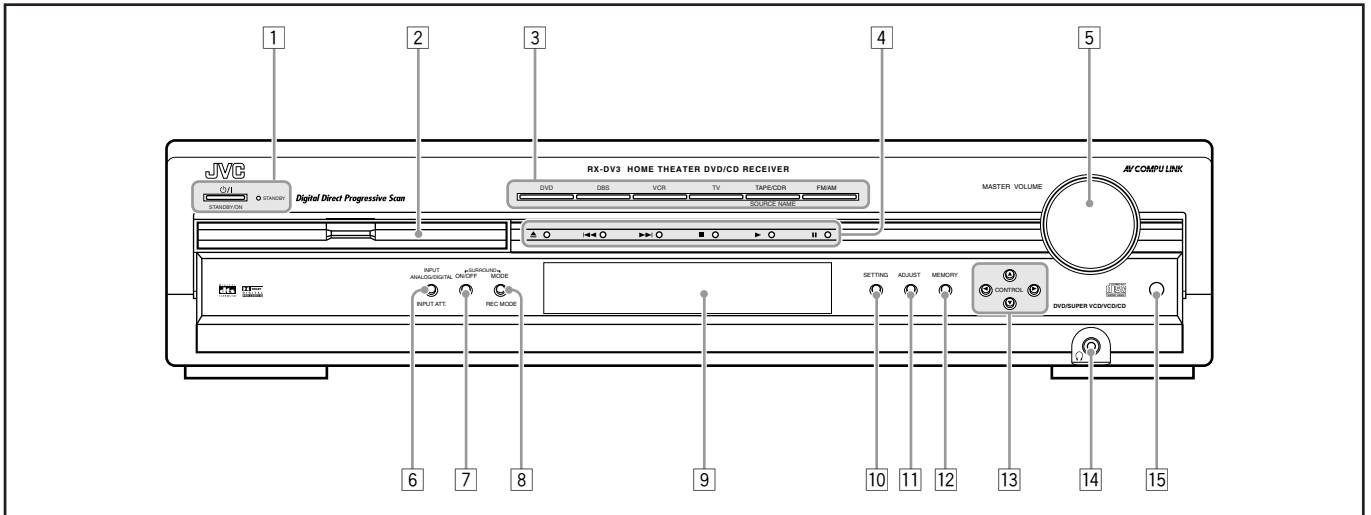

See pages in the parentheses for details.

- | | |
|---|--|
| <p>1 ⏻/STANDBY/ON button and STANDBY lamp (11)</p> <p>2 Disc tray and illumination lamp (15)</p> <p>3 Source selecting buttons (11, 13)</p> <ul style="list-style-type: none"> • DVD, DBS, VCR, TV, TAPE/CDR, FM/AM <p>SOURCE NAME button (12)</p> <p>4 DVD player operation buttons,</p> <ul style="list-style-type: none"> ▲ (open/close), ◀◀ (reverse skip), ▶▶ (forward skip), ■ (stop), ▶ (play), ⏸ (pause) <p>5 MASTER VOLUME control (11, 16)</p> <p>6 INPUT ANALOG/DIGITAL button (13)</p> <p>INPUT ATT (Attenuator) button (14)</p> | <p>7 SURROUND ON/OFF button (16, 27)</p> <p>8 SURROUND MODE button (16, 27)</p> <p>REC MODE button (14)</p> <p>9 Display</p> <ul style="list-style-type: none"> • For details, see “Display” below. <p>10 SETTING button (19 – 22)</p> <p>11 ADJUST button (23, 24)</p> <p>12 MEMORY button (17)</p> <p>13 CONTROL ▲ / ▼ / ◀ / ▶ buttons (17 – 24)</p> <p>14 ♻ (phones) jack (11)</p> <p>15 Remote sensor</p> |
|---|--|

Display

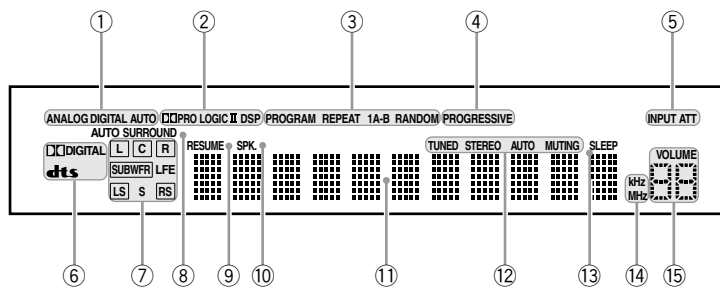

- | | |
|---|---|
| <p>1 Input mode indicators (13)</p> <ul style="list-style-type: none"> • ANALOG, DIGITAL AUTO, AUTO <p>2 Surround mode indicators (25, 26)</p> <ul style="list-style-type: none"> • DIGITAL, DSP <p>3 Play mode indicators (41, 42, 44, 46)</p> <ul style="list-style-type: none"> • PROGRAM, REPEAT 1A-B, RANDOM <p>4 PROGRESSIVE indicator (14)</p> <p>5 INPUT ATT indicator (14)</p> <p>6 Sound signal indicators (13)</p> <ul style="list-style-type: none"> • DIGITAL (Dolby Digital), DTS (DTS Digital Surround) <p>7 Signal and speaker indicators (27)</p> <ul style="list-style-type: none"> • L, C, R, SUBWFR (Subwoofer), LFE (Low Frequency Effect), LS, S, RS | <p>8 Surround indicators (27)</p> <ul style="list-style-type: none"> • AUTO SURROUND, SURROUND <p>9 RESUME indicator (16)</p> <p>10 SPK. (speaker) indicator (11)</p> <p>11 Main display</p> <p>12 Tuner mode indicators (17, 18)</p> <ul style="list-style-type: none"> • TUNED, STEREO, AUTO MUTING <p>13 SLEEP indicator (12)</p> <p>14 Frequency unit indicators</p> <ul style="list-style-type: none"> • MHz (for FM station), kHz (for AM station) <p>15 VOLUME indication</p> |
|---|---|

Remote Control

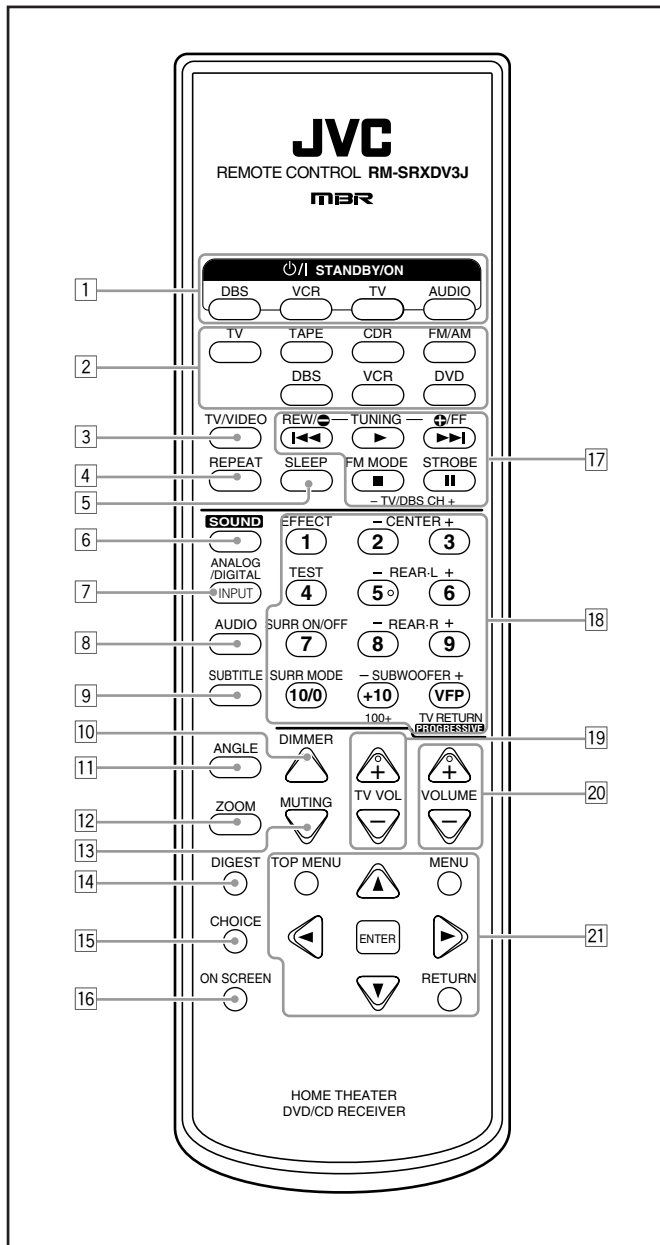

See pages in the parentheses for details.

- 1 O/I STANDBY/ON buttons (11, 60 – 63)
 - DBS, VCR, TV, AUDIO
- 2 Source selecting buttons (11, 13, 59 – 63)
 - TV, TAPE, CDR, FM/AM, DBS, VCR, DVD
- 3 TV/VIDEO button (15, 60, 61)
- 4 REPEAT button (42, 44, 46)
- 5 SLEEP button (12)
- 6 SOUND button (24, 27, 28)
- 7 ANALOG/DIGITAL INPUT button (13)
- 8 AUDIO button (35, 36)
- 9 SUBTITLE button (35)
- 10 DIMMER button (12)
- 11 ANGLE button (34)
- 12 ZOOM button (39)
- 13 MUTING button (12)
- 14 DIGEST button (38)
- 15 CHOICE button (47, 48)
- 16 ON SCREEN button (31, 32, 34 – 38, 41, 42)
- 17 Multi operation buttons
 - $\lll, \ggg, \blacksquare, \text{II}, \text{REW}, \text{FF}$
 - TUNING \oplus and \ominus buttons (17)
 - FM MODE button (18)
 - STROBE button (39)
 - TV/DBS CH (channel) + and – buttons (60, 61)
- 18 Number buttons
 - For selecting preset channels (18)
 - For adjusting sound (24, 28, 59)
 - For operating audio/video components (59 – 63)
 - SURR (surround) ON/OFF button (16, 27)
 - SURR (surround) MODE button (16, 27)
 - VFP button (40)
 - TV RETURN button (60, 61)
 - PROGRESSIVE button (14)
- 19 TV VOL (volume) + and – buttons (60, 61)
- 20 VOLUME + and – buttons (11, 16)
- 21 Menu operation buttons
 - TOP MENU button (33)
 - MENU button (33)
 - RETURN button (33)
 - ENTER button
 - Cursor ($\blacktriangle / \blacktriangledown / \blacktriangleright / \blacktriangleleft$) buttons

Getting Started

Before Installation

General Precautions

- DO NOT insert any metal object into the unit.
- DO NOT disassemble the unit or remove screws, covers, or cabinet.
- DO NOT expose the unit to rain or moisture.

Locations

- Install the unit in a location that is level and protected from moisture.
- The temperature around the unit must be between -5°C and 35°C (23°F and 95°F).
- Make sure there is good ventilation around the unit. Poor ventilation could cause overheating and damage the unit.

Handling the unit

- DO NOT touch the power cord with wet hands.
- DO NOT pull on the power cord to unplug it. When unplugging the cord, always grasp the plug so as not to damage the cord.
- Keep the power cord away from the connecting cords and the antenna. The power cord may cause noise or screen interference. It is recommended to use a coaxial cable for antenna connection, since it is well-shielded against interference.
- When a power failure occurs, or when you unplug the power cord, the preset settings such as preset FM or AM channels and sound adjustments may be erased in a few days.

Checking the Supplied Accessories

Check to be sure you have all of the following supplied accessories. The number in the parentheses indicates the quantity of the pieces supplied.

- Remote Control (1)
- Batteries (2)
- AM Loop Antenna (1)
- FM Antenna (1)
- Composite Video Cord (1)

If anything is missing, contact your dealer immediately.

Putting Batteries in the Remote Control

Before using the remote control, put two supplied batteries first.

- When using the remote control, aim the remote control directly at the remote sensor on the unit.

1 On the back of the remote control, remove the battery cover.

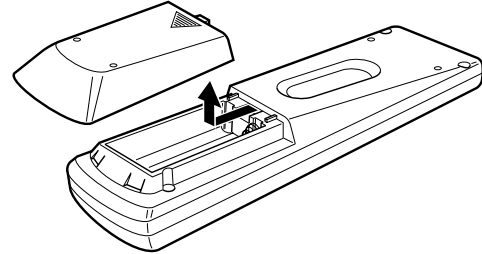

2 Insert batteries. Make sure to match the polarity: (+) to (+) and (-) to (-).

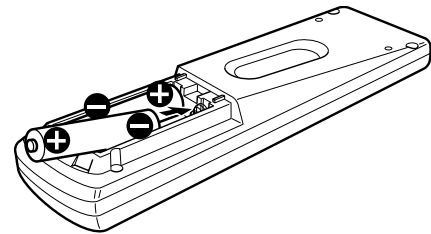

3 Replace the cover.

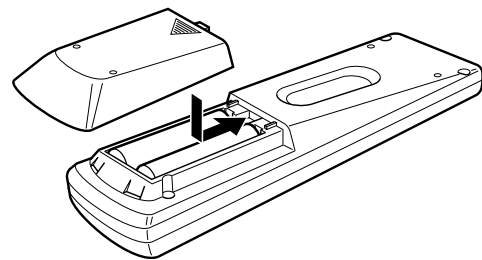

If the range or effectiveness of the remote control decreases, replace the batteries. Use two R6P(SUM-3)/AA(15F) type dry-cell batteries.

CAUTION:

Follow these precautions to avoid leaking or cracking cells:

- Place batteries in the remote control so they match the polarity: (+) to (+) and (-) to (-).
- Use the correct type of batteries. Batteries that look similar may differ in voltage.
- Always replace both batteries at the same time.
- Do not expose batteries to heat or flame.

Getting Started

Connecting the FM and AM Antennas

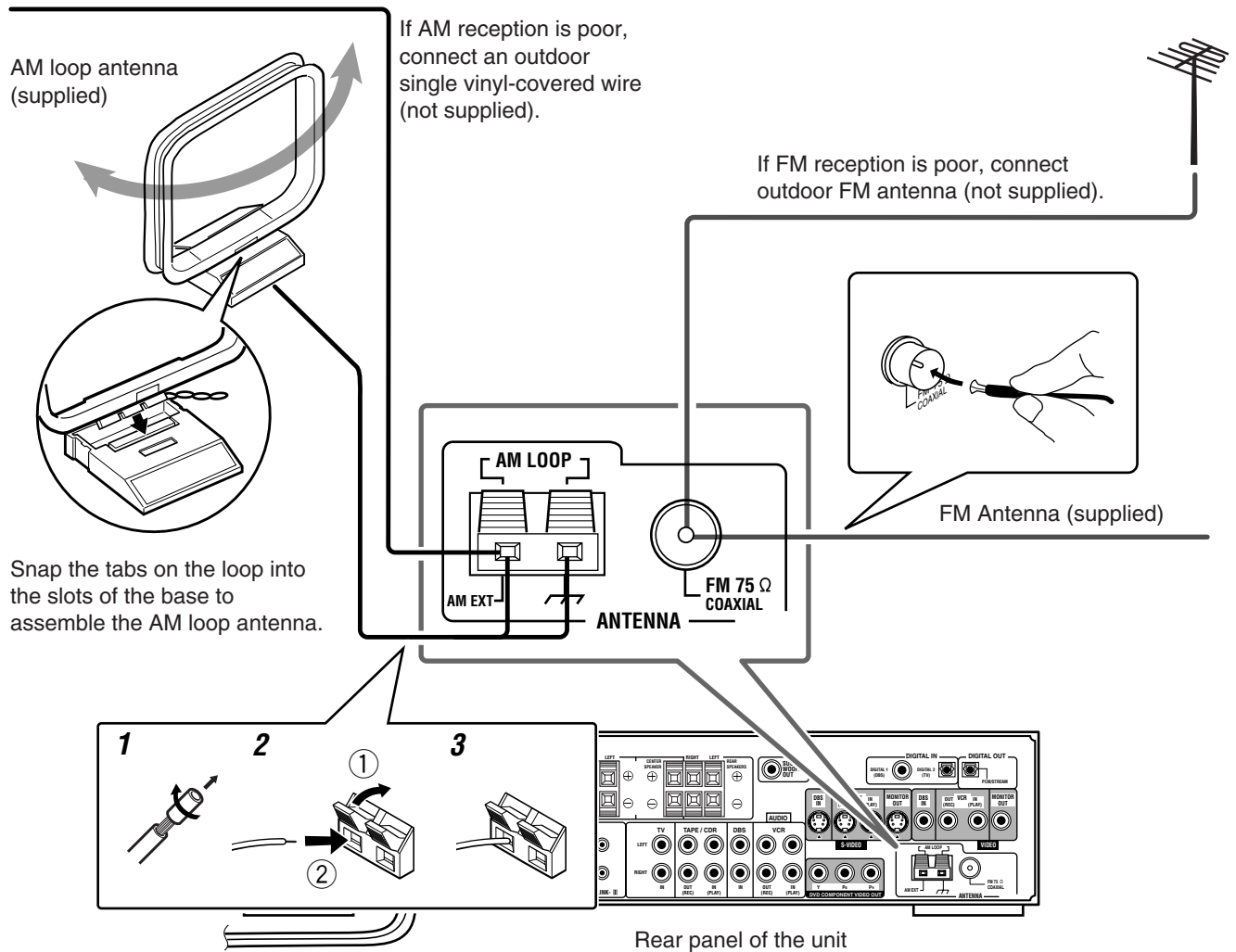

AM antenna connection

Connect the AM loop antenna supplied to the AM LOOP terminals.

- 1 Remove the insulation if the AM loop antenna wire is covered with vinyl.
- 2 Press and hold the clamp of the terminal (①), then insert the wire (②).
- 3 Release the clamp.

Turn the loop until you have the best reception.

- If the reception is poor, connect an outdoor single vinyl-covered wire (not supplied) to the AM EXT terminal. Keep the AM loop antenna connected.

FM antenna connection

Connect the FM antenna supplied to the FM 75 Ω COAXIAL terminal as temporary measure.

Extend the supplied FM antenna horizontally.

- If the reception is poor, connect an outdoor FM antenna (not supplied). Before attaching a 75 Ω coaxial cable (with a standard type connector), disconnect the supplied FM antenna.

Note:

- Make sure the antenna conductors do not touch any other terminals, connecting cords and power cord. This could cause poor reception.

Connecting the Speakers

After connecting the front, center and rear speakers, and/or a subwoofer, set the speaker setting information properly to obtain the best possible Surround effect. For details, see page 20.

CAUTIONS:

- Use speakers with the SPEAKER IMPEDANCE indicated by the speaker terminals (8 – 16 Ω).
- DO NOT connect more than one speaker to one speaker terminal.

Connecting the front, center, and rear speakers

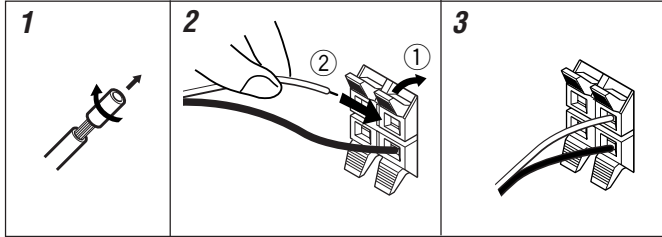

For each speaker, connect the (+) and (–) terminals on the rear panel to the (+) and (–) terminals marked on the speakers respectively.

- 1 Cut, twist and remove the insulation at the end of each speaker cord (not supplied).
- 2 Press and hold the clamp of the speaker terminal (①), then insert the speaker cord (②).
- 3 Release the clamp.

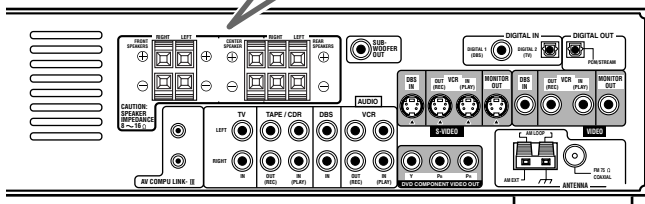
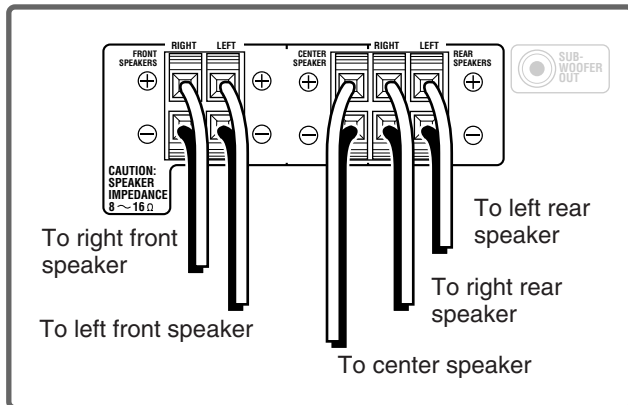

Connecting the subwoofer speaker

By connecting a subwoofer, you can enhance the bass or reproduce the original LFE signals recorded in the digital software.

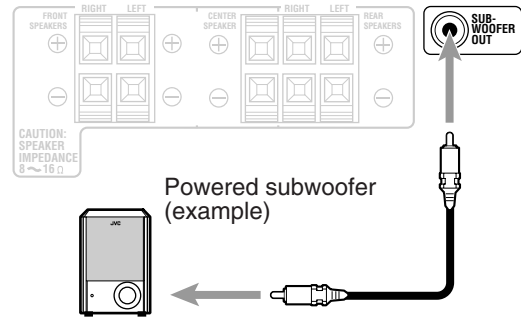

Connect the input jack of a powered subwoofer to the SUBWOOFER OUT jack on the rear panel, using a cable with RCA pin plugs (not supplied).

- Refer also to the manual supplied with your subwoofer.

Note:

- You can place a subwoofer wherever you like since bass sound is non-directional. Normally place it in front of you.

Speaker Layout Diagram

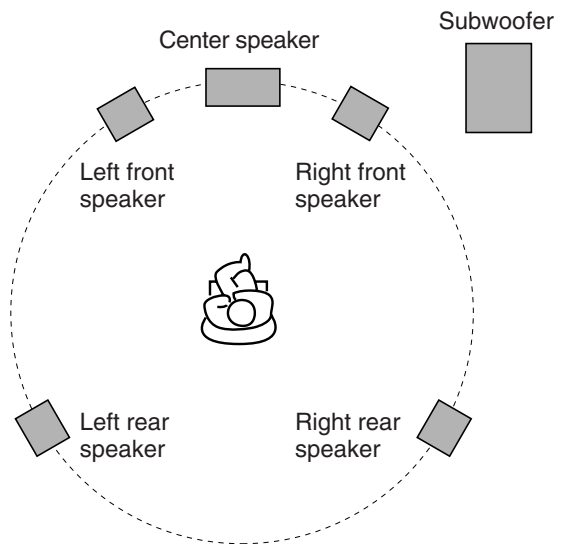

To obtain the best possible sound from this system, place all the speakers except the subwoofer at the same distance from the listening position with each speaker's front faced toward the listener.

Then, change the subwoofer and speaker settings to fit your listening conditions (see page 20).

Getting Started

Connecting Audio/Video Components

Turn off all the components and the unit before connection.

■ About connecting cords

For video connections

The S-video cords and the component video cord are not supplied with this unit.
Use the cords supplied with the other components or purchase them at your dealer.

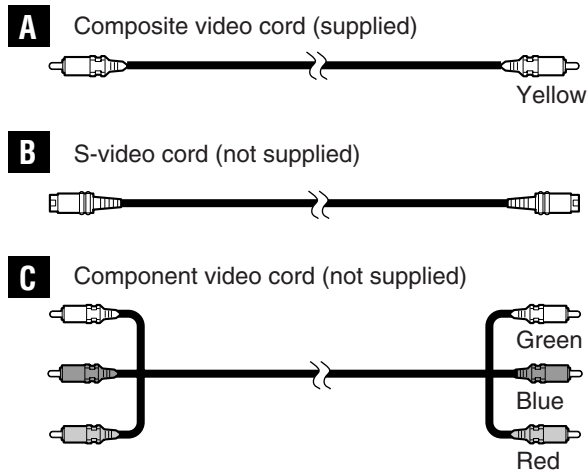

- You can use composite video cord (**A**) and/or S-video cord (**B**) for connecting DBS tuner and VCR to this unit.
- You can use component video cord (**C**) in addition to **A** and **B** for connecting your TV to this unit.
- By using **B** or **C**, you can get a better picture quality—in the order: **A** < **B** < **C**.
- To view the picture from DBS tuner or VCR on your TV, connect your TV to this unit using the same type of cord for connecting DBS tuner or VCR to this unit.
- To view the picture from the built-in DVD player, connect the TV to this unit using **A**, **B**, and/or **C**, then register the video output mode correctly (see “Video output mode” on page 22).
- To enjoy the progressive video picture, connect the TV compatible with the progressive video input using **C**, then change the scanning mode correctly (see “Changing the Scanning Mode” on page 14).

For audio connections

Connect the external components to this unit with the audio cords.
Use the cord supplied with the other components or purchase them at your dealer.

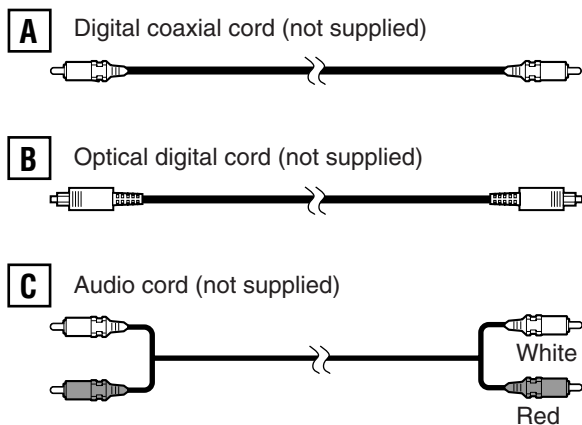

- When the unit is shipped from the factory, the DIGITAL IN terminals are set for use with the following components:
 - DIGITAL 1 (coaxial): For DBS tuner
 - DIGITAL 2 (optical): For TV
- If you connect CDR, change the digital input (DIGITAL IN) terminal setting (see “Digital input (DIGITAL IN) terminals” on page 21) and the source name (see “Changing the Source Name” on page 12) correctly.
- Select the digital input mode correctly (see “Selecting the Analog or Digital Input Mode” on page 13).

Turn off all the components and the unit before connection.

Illustrations of the input/output terminals below are typical examples. When you connect other components, refer also to their manuals since the terminal names actually printed on the rear vary among the components.

TV connection

Video connections

DO NOT connect a TV through a VCR or a TV with a built-in VCR; Otherwise, the picture may be distorted.

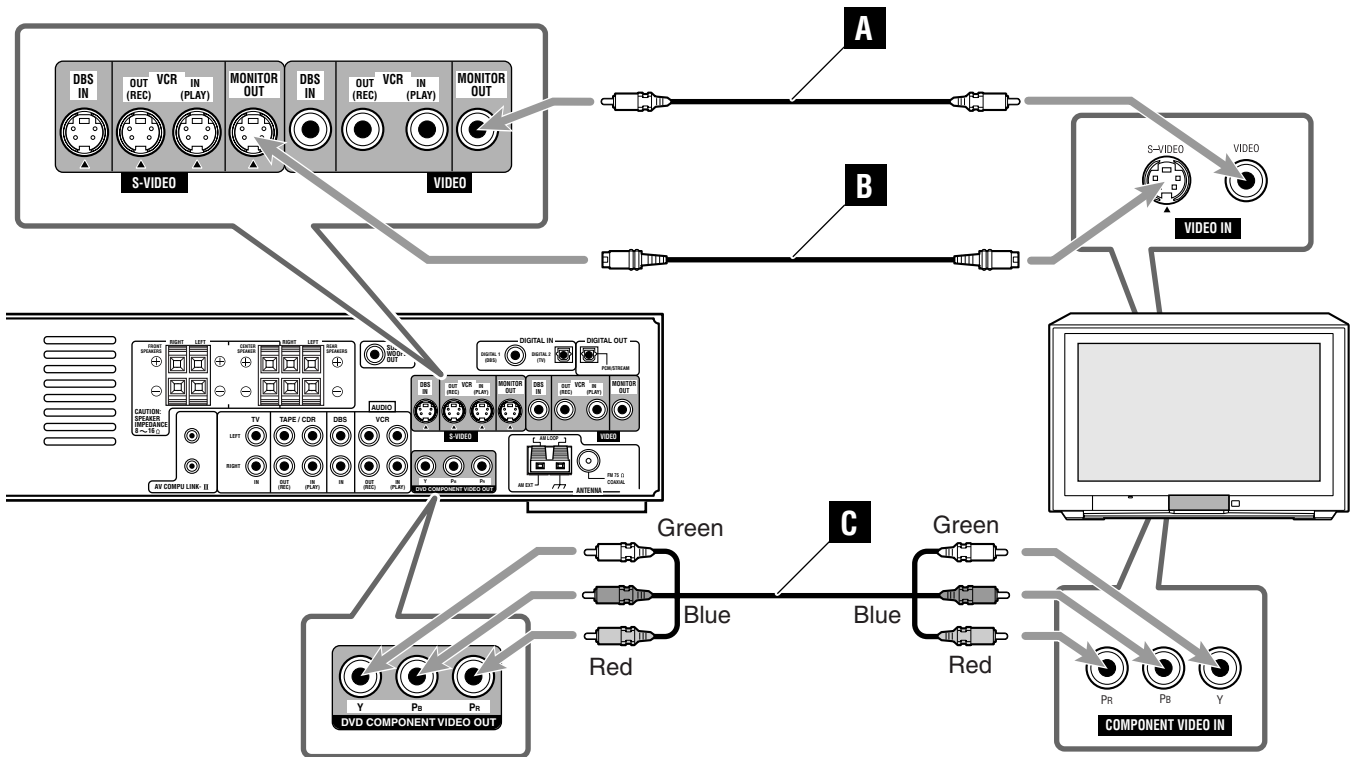

Audio connections

Before connecting an optical digital cord, unplug the protective plug.

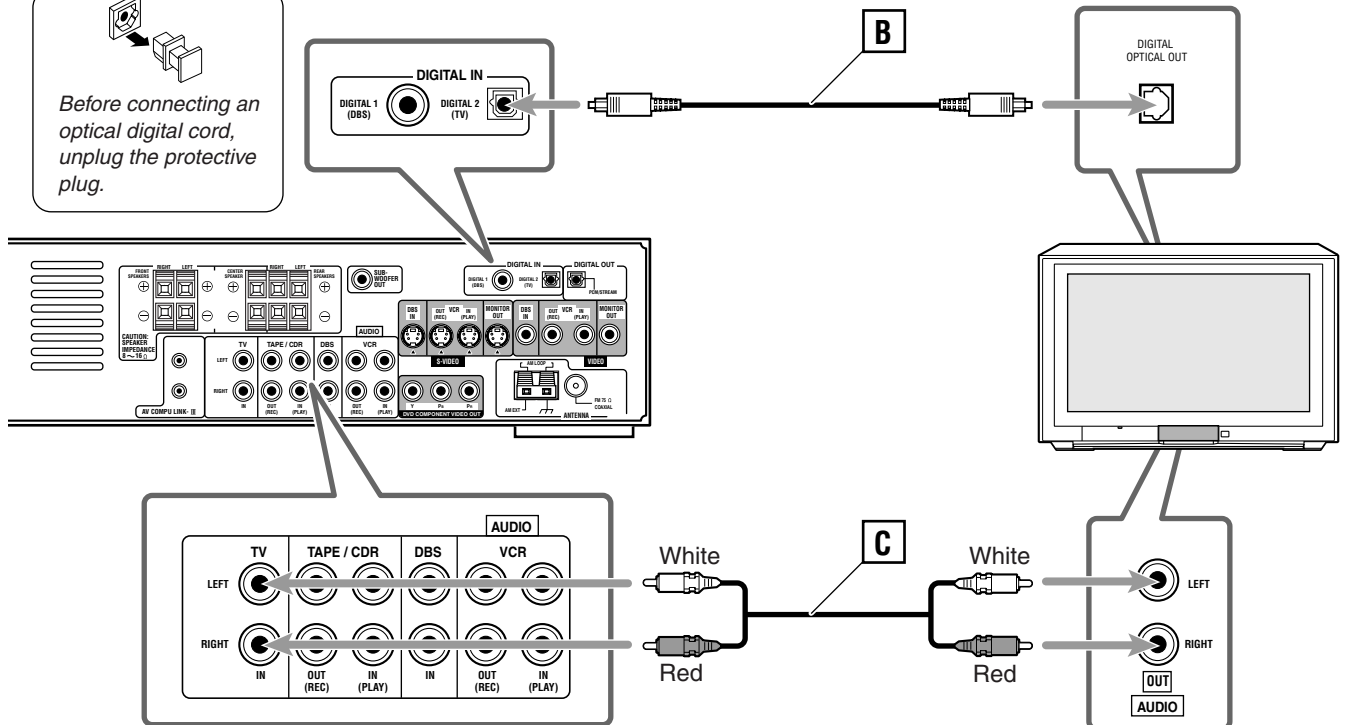

Getting Started

Turn off the TV and the unit before connection.

Illustrations of the input/output terminals below are typical examples. When you connect other components, refer also to their manuals since the terminal names actually printed on the rear vary among the components.

VCR connection

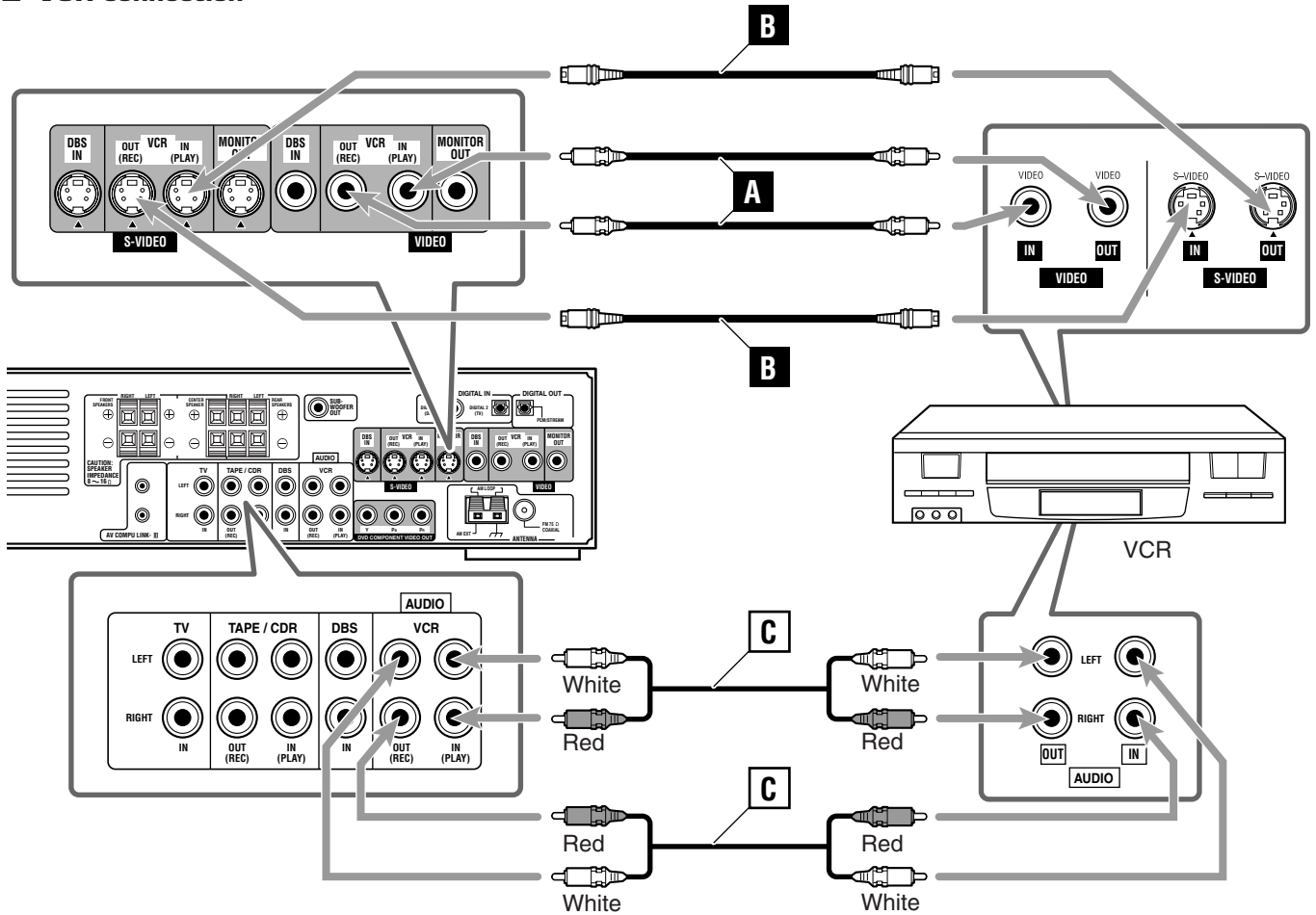

DBS tuner connection

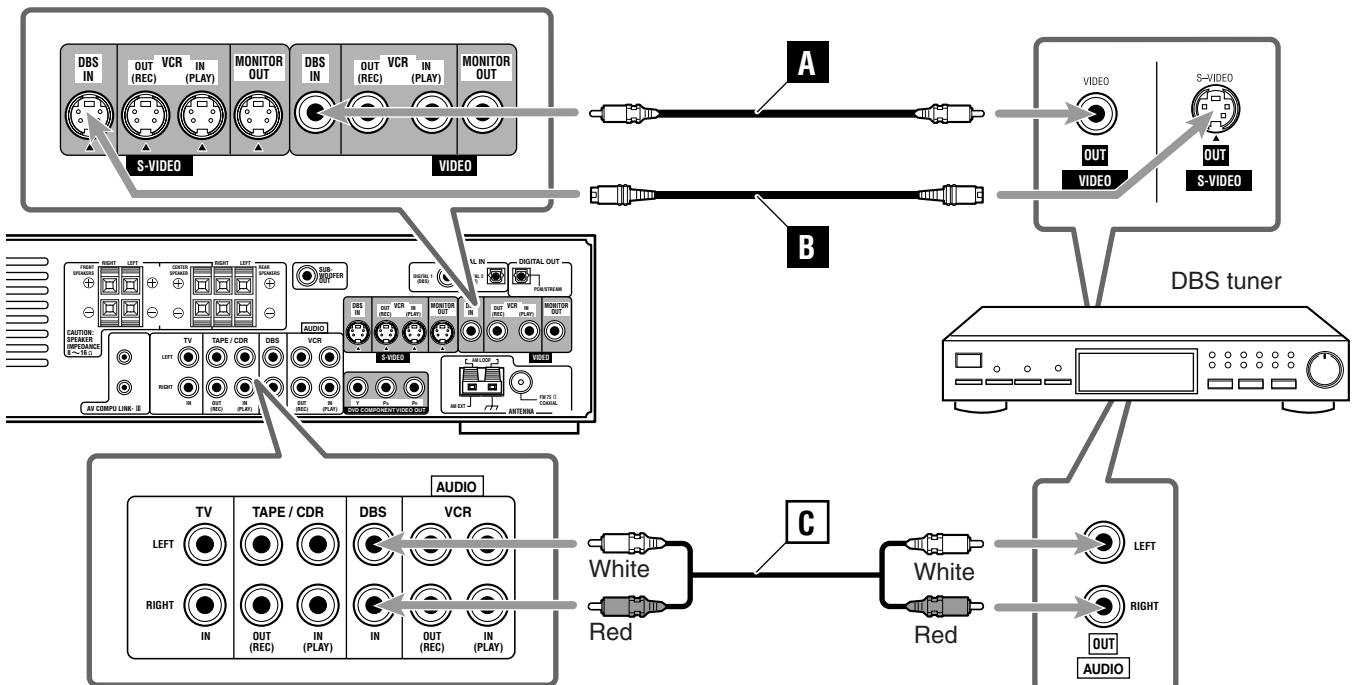

■ Cassette deck/CD recorder connection

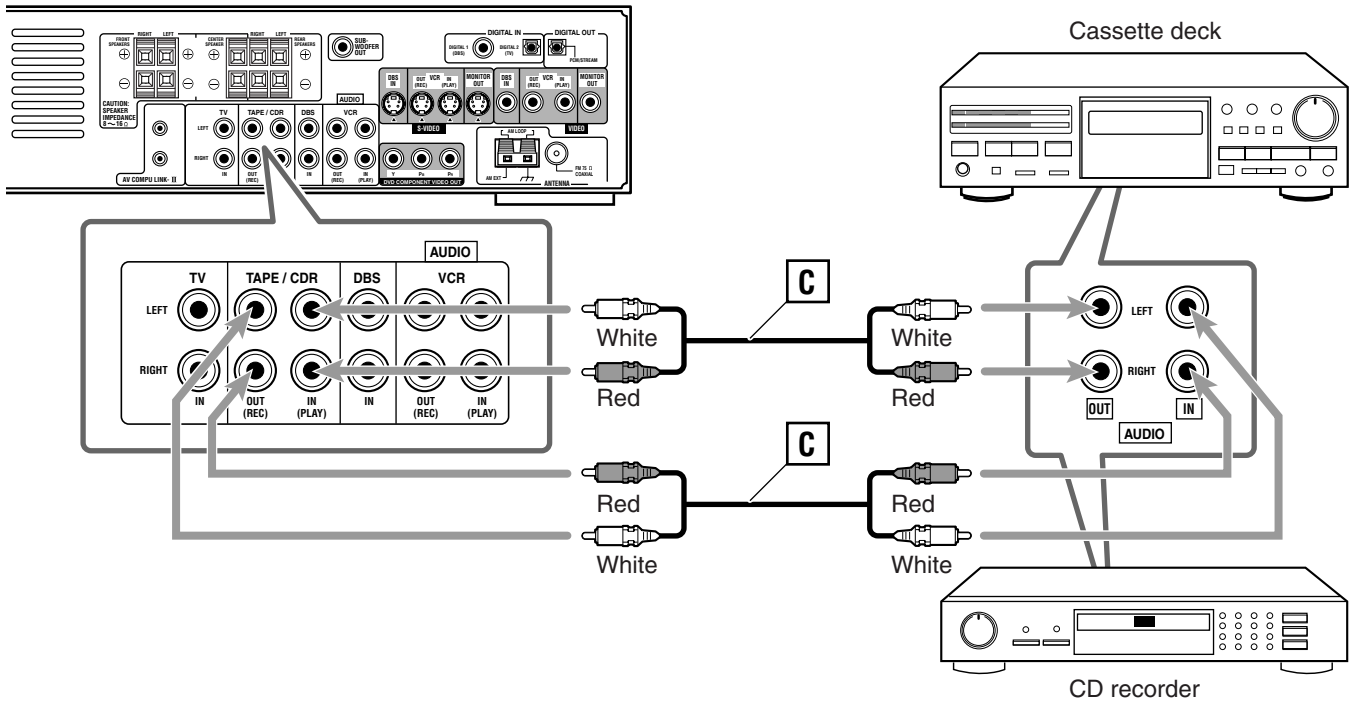

■ Digital connection

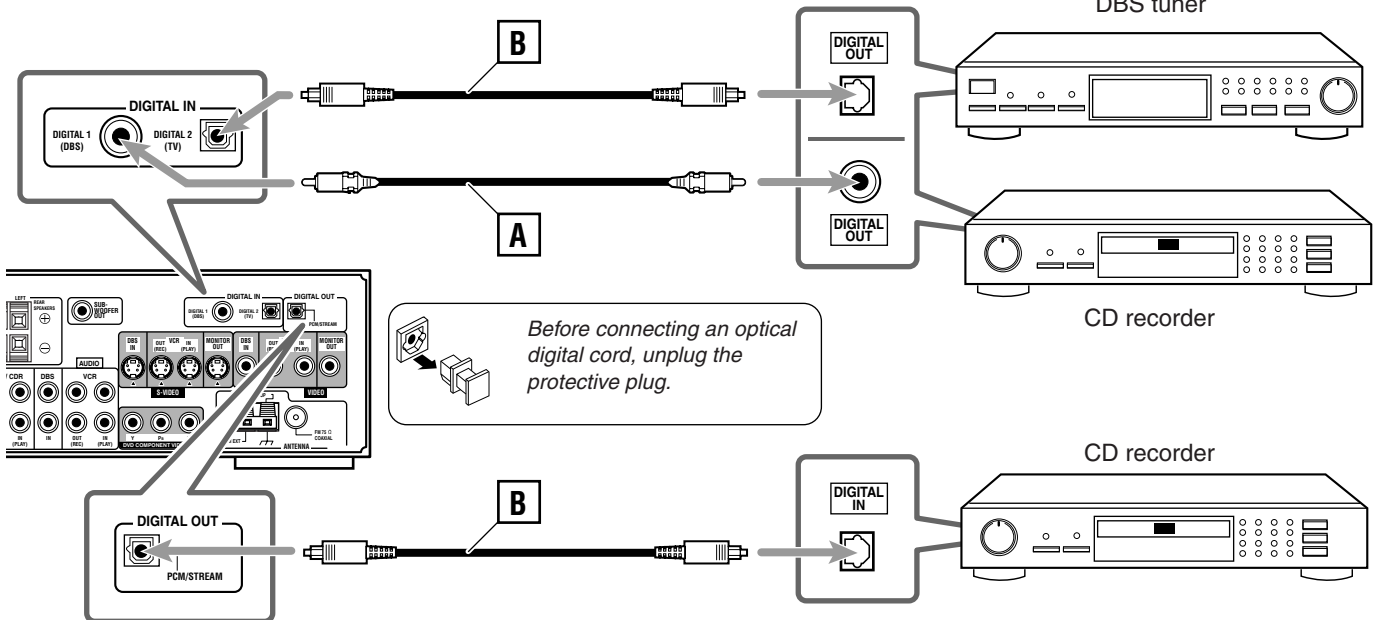

Now, you can plug the power cord of the unit into the AC outlet.

CAUTIONS:

- Do not touch the power cord with wet hands.
- Do not pull on the power cord to unplug the cord. When unplugging the cord, always grasp the plug so as not to damage the cord.

Notes:

- Keep the power cord away from the connecting cords and the antenna cables. The power cord may cause noise or screen interference.
- The preset settings such as preset channels and sound adjustment may be erased in a few days in the following cases:
 - When you unplug the power cord
 - When a power failure occurs

Basic Operations

1 Turn On the Power

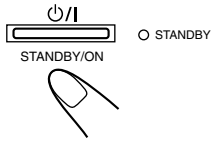

On the front panel

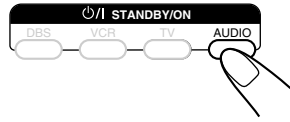

From the remote control

Press **STANDBY/ON** on the front panel or **STANDBY/ON AUDIO** on the remote control.

The STANDBY lamp goes off and the illumination lamp lights up. The current source name appears on the display.

- If the built-in DVD player is the current source, “READING” appears while the unit is detecting the type of the loaded disc (see page 29).
 - Playback starts automatically when you load some DVD VIDEO.
 - “NO DISC” appears on the display when no disc is loaded.

To turn off the power (into standby)

Press **STANDBY/ON** on the front panel or **STANDBY/ON AUDIO** on the remote control again.

The illumination lamp goes off and the STANDBY lamp lights up.

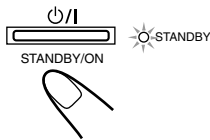

Note:

- A small amount of power is consumed even in standby mode. To turn the power off completely, unplug the AC power cord.

2 Select the Source to Play



On the front panel

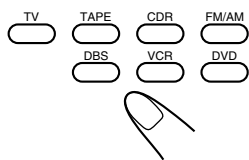

From the remote control

Press one of the source selecting buttons.

- DVD : Select the built-in DVD player.
- DBS* : Select the DBS.
- VCR : Select the VCR.
- TV* : Select the TV tuner.
- TAPE/CDR* : Select the cassette deck or the CD recorder (front panel ONLY)
- TAPE : Select the cassette deck (remote control ONLY**).
- CDR* : Select the CD recorder (remote control ONLY**).
- FM/AM : Select an FM or AM broadcast.

Notes:

* Register the digital input terminal setting (see “Digital input (DIGITAL IN) terminals” on page 21) and digital input mode setting correctly (see “Selecting the Analog or Digital Input Mode” on page 13). Source name and “DIGITAL” will come to be shown on the display when you select the source.

**When the source name is not assigned correctly, these buttons cannot work (see “Changing the Source Name” on page 12).

3 Adjust the Volume

On the front panel:

To increase the volume, turn MASTER VOLUME clockwise.

To decrease the volume, turn MASTER VOLUME counterclockwise.

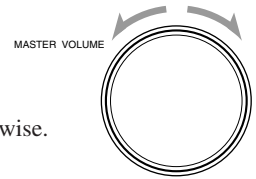

From the remote control:

To increase the volume, press and hold VOLUME +.

To decrease the volume, press and hold VOLUME -.



CAUTION:

Always set the volume to the minimum before starting any sources. If the volume is set at a high level, the sudden blast of sound energy can permanently damage your hearing and/or ruin your speakers.

Notes:

- The volume level can be adjusted within the range of “0” (minimum) to “50” (maximum).
- When DVD is selected as the source with your TV turned on, the volume level indication appears on the TV.

Listening with headphones

Connect a pair of headphones to the Ω (phones) jack on the front panel. This cancels the Surround mode currently selected, deactivates speakers, and activates the HEADPHONE mode.



The SPK. indicator goes off from the display.

- Disconnecting a pair of headphone from the Ω (phones) jack cancels the HEADPHONE mode and activates speakers.

HEADPHONE mode

When using the headphones, the following signals are output regardless of your speaker setting:

- For 2-channel sources, the front left and right channel signals are output directly from the left and right headphones.
- For multichannel sources, the front left and right, center and rear channel signals are down-mixed and then output from the headphones without missing bass element.
You can enjoy multichannel sound source using the headphones.

CAUTION:

Be sure to turn down the volume:

- Before connecting or putting on headphones, as high volume can damage both the headphones and your hearing.
- Before removing headphones, as high volume may output from the speakers.

Turning Off the Sounds Temporarily

From the remote control ONLY



Press MUTING to mute the sound.

“MUTING” appears on the display and the volume turns off (the volume indication goes off).

- When DVD is selected as the source with your TV turned on, “VOLUME –” appears on the TV.



To restore the sound

Press MUTING again.

- Pressing VOLUME + or – on the remote control (or turn MASTER VOLUME on the front panel) also restores the sound.

Turning Off the Power with the Sleep Timer

From the remote control ONLY



Press SLEEP repeatedly.

The SLEEP indicator lights up on the display.

- Each time you press the button, the shut-off time changes as follows:

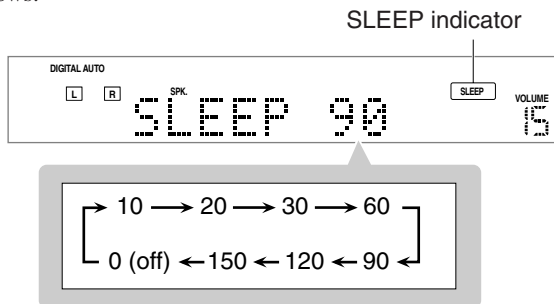

When the shut-off time comes

The unit is turned off automatically.

To check or change the remaining time until the shut-off time

Press SLEEP once.

The remaining time (in minutes) until the shut-off time appears.

- To change the shut-off time, press SLEEP repeatedly.

To cancel the Sleep Timer

Press SLEEP repeatedly until “SLEEP 0” appears on the display. (The SLEEP indicator goes off.)

- Turning off the unit also cancels the Sleep Timer.

Note:

- When DVD is selected as the source, If Auto Standby (see page 52) is used with Sleep Timer, the unit will be turned off with one of the functions having an early shut-off time.

Changing the Display Brightness

From the remote control ONLY



Press DIMMER to dim the display.

- Each time you press the button, the display and illumination lamp dim and brighten alternately.

Changing the Source Name

When you connect an CD recorder to the TAPE/CDR jacks on the rear panel, change the source name which will be shown on the display.

From the front panel ONLY

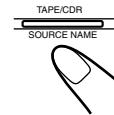

Ex. : When changing the source name from “TAPE ” to “CDR”

1 Press TAPE/CDR (SOURCE NAME) to select as the source.

2 Press and hold SOURCE NAME (TAPE/CDR) until “ASSGN. CDR” appears on the display.

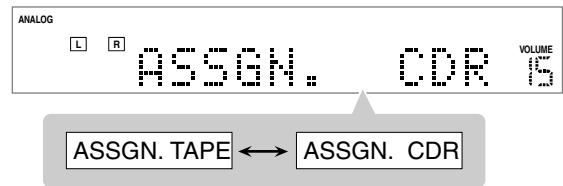

To change the source name to “TAPE”

Press and hold SOURCE NAME (TAPE/CDR) until “ASSGN. TAPE” appears on the display in step 2.

Note:

- Without changing the source name, you can still use the connected components. However, there may be some inconveniences:
 - The unexpected source name will appear on the display when you press TAPE/CDR (SOURCE NAME) on the front panel.
 - The CDR or TAPE button on the remote control cannot work for selecting the source.
 - You cannot use the digital input (see page 10) for the CD recorder.

Basic Operations

Selecting the Analog or Digital Input Mode

When you have connected digital source components using both the analog connection and the digital connection methods (see pages 7 to 10), you can select the input mode.

- Before selecting the digital input mode, register the digital input terminal setting correctly (see “Digital input (DIGITAL IN) terminals” on page 21).

1 Press one of the source selecting buttons (DBS, TV, or CDR) for which you want to change the input mode.

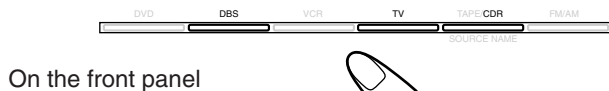

On the front panel

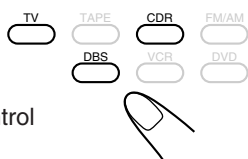

From the remote control

Note:

- You cannot change the input mode when selecting DVD as the source. Digital input is always used for the built-in DVD player.

2 Press INPUT ANALOG/DIGITAL (INPUT ATT.) or ANALOG/DIGITAL INPUT on the remote control.



On the front panel



From the remote control

The current input mode appears on the display.

- Each time you press the button, the input mode alternates between the analog input (“ANALOG”*) and the digital input (“DGTL AUTO”).

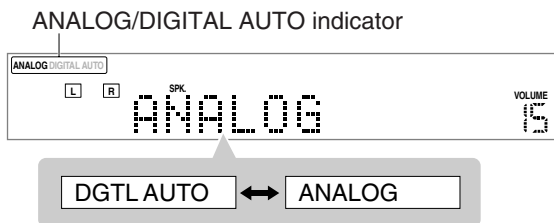

- * “ANALOG” is the initial setting except for the built-in DVD player.

DGTL AUTO : Select this for the digital input mode.
The DIGITAL AUTO indicator lights up.
The unit automatically detects the incoming signal format, then the digital signal indicator for the detected signal—**DIGITAL** or **dts** lights up; otherwise, no digital signal indicators light up.

ANALOG : Select this for the analog input mode.
The ANALOG indicator lights up.

Changing the Digital Input Mode Manually

If the following symptoms occur while Dolby Digital or DTS Digital Surround software is played back, you can change the digital input mode:

- Sound does not come out at the beginning of playback.
- Noise comes out while searching for or skipping chapters or tracks.

On the front panel

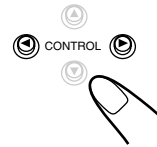

Press CONTROL ► (or ◀) to select “DGTL D.D.” or “DGTL DTS” while “DGTL AUTO” still remains on the display.

- Each time you press the button, the digital input mode changes as follows:

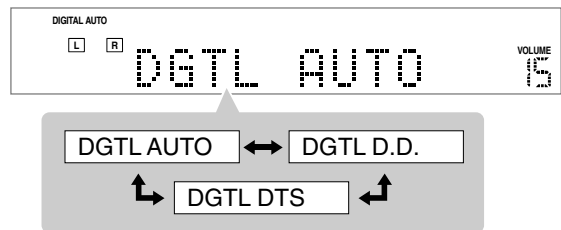

- DGTL AUTO** : Normally select this.
The DIGITAL AUTO indicator lights up.
The unit automatically detects the incoming signal format, then the digital signal indicator for the detected signal lights up.
- DGTL D.D.** : Select this for playing back software encoded with Dolby Digital.
The **DIGITAL** indicator lights up*.
- DGTL DTS** : Select this for playing back software encoded with DTS Digital Surround.
The **dts** indicator lights up*.

- * These indicators flash when no signal or the signal without the proper format is played back.

When DVD is selected as the source, you can also change the digital input mode by pressing ANALOG/DIGITAL INPUT repeatedly on the remote control.



Notes:

- When “DGTL AUTO” cannot recognize the incoming signals, no digital signal indicators light up on the display.
- When you turn off the unit or select another source, “DGTL DTS” and “DGTL D.D.” are canceled.
The digital input mode is automatically reset to “DGTL AUTO.”

Attenuating the Input Signal

When the input level of the **analog source** is too high, the sounds will be distorted. If this happens, you need to attenuate the input signal level to prevent the sound distortion.

- You have to make this adjustment for each **analog source**.

On the front panel ONLY



Press and hold INPUT ATT (INPUT ANALOG/DIGITAL) until the INPUT ATT indicator lights up on the display.

- Each time you press and hold the button, the Input Attenuator turns on (“ATT ON”) or off (“ATT NORMAL”).

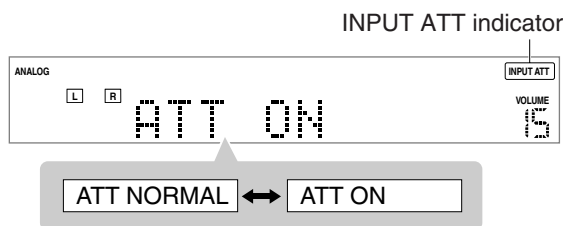

ATT NORMAL : Normally select this. The analog sound is not attenuated.

ATT ON : Select this when the analog sound is distorted.

Changing the Scanning Mode

This unit supports the progressive scanning system (480p*) as well as the conventional interlaced scanning system (480i*).

If your TV has component video jacks and supports the progressive video input, you can enjoy a high quality picture from the built-in DVD player.

- Refer also to the instruction manuals supplied with your TV.
- You can select the progressive mode according to the original picture type (film or video source). See page 49.
- Do not change the scanning mode to “PROGRESSIVE” in the following cases:
 - when your TV does not support the progressive video input
 - when you do not connect your TV to the unit using component video cord

From the remote control ONLY



Press and hold PROGRESSIVE for more than 3 seconds when DVD is selected as the source.

- The current scanning mode appears on the display for a while.
- Each time you press and hold the button, the scanning mode changes “INTERLACE” and “PROGRESSIVE” alternately.

INTERLACE : Select this for conventional TV.

PROGRESSIVE : Select this if your TV with component jacks supports the progressive video input. The PROGRESSIVE indicator lights up.

Notes:

- Some progressive TVs and High-Definition TVs are not fully compatible with this system. When a DVD VIDEO is played back in the progressive scanning mode on those TVs, the unnatural picture may result. In such a case, change the scanning mode to “INTERLACE.” To check the compatibility of your TV, contact your dealer. All JVC progressive TVs and High-Definition TVs are fully compatible with this system respectively.
- When you select “PROGRESSIVE” as the scanning mode, the picture does not come out correctly through composite video and S-video jacks.
- 480p and 480i indicate the number of scanning lines and scanning format of an image signal.
 - 480p indicates 480 scanning lines with progressive format.
 - 480i indicates 480 scanning lines with interlaced format.

Activating the Recording Mode

You can record the sounds from any of sources playing through the unit to the VCR or the cassette deck. In particular, for multichannel sources, Recording mode enables you to record the sounds without missing surround elements by down-mixing the center, rear channel, and LEF channel signals into the front channel signals.

- Recording mode also takes effect for the sounds from the speakers. When the multichannel software is played back with Recording mode activated, the sounds are down-mixed and come out through the front speakers only.

On the front panel ONLY

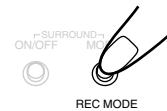

Press and hold REC MODE (SURROUND MODE) until “RECMODE ON” appears on the display.

- Each time you press and hold the button, Recording mode is activated (“RECMODE ON”) and deactivated (“RECMODE OFF”) alternately.

RECMODE OFF : Normally select this. The down-mixing is canceled.

RECMODE ON : Select this for recording the down-mixed sounds.

When recording with VCR:

While Recording mode is activated (“RECMODE ON”), the volume level indication and the on-screen guide icons (see page 52) do not appear on the TV.

- The choice menu and the on-screen bar are recorded even though Recording mode is activated (“RECMODE ON”).

CAUTION:

When the front speakers are small, the output sound may be distorted by Recording mode. In this case, decrease the volume until the sound distortion diminishes.

Notes:

- When you turn off the unit or select another source, Recording mode is canceled (“RECMODE OFF”).
- Sound adjustments (see pages 23 and 24) and Surround modes (see pages 25 to 28) do not affect the recording.
- The following buttons do not work while Recording mode is activated (“RECMODE ON”):
 - SETTING and ADJUST on the front panel
 - SURROUND ON/OFF and SURROUND MODE on the front panel
 - Number buttons for adjusting sound on the remote control

Basic DVD Player Operations

For details about DVD player operations, see pages 29 to 42.

- You can also play back MP3 and JPEG files. See pages 43 to 46.

- When using remote control, press DVD to change the remote control operation mode to the DVD player operation.

1 Open the Disc Tray

Before turning on the unit, turn on your TV and select the correct video input (see the manual supplied with your TV).

- When you use a JVC's TV, you can turn on your TV by pressing \odot /I STANDBY/ON TV on the remote control and select the video input by pressing TV/VIDEO. (If your TV is not a JVC's, see "Operating Other Manufacturers' Equipment" on page 61.)
- For changing the OSD messages—the information on the TV—into the desired language, see pages 47 and 49.

From the front panel ONLY



Press \blacktriangle .

The unit is turned on and the disc tray opens.

The STANDBY lamp goes off and the illumination lamp lights up.

- When a disc is already loaded, pressing \blacktriangleright turns on the unit and starts playing back the loaded disc.

2 Load a Disc

Place a disc correctly with its label side up.

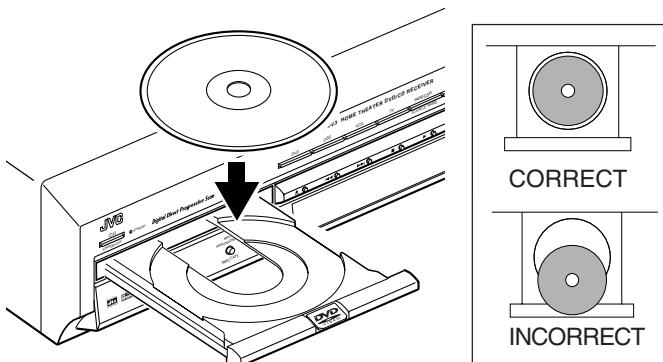

3 Start Playback



On the front panel



From the remote control

Press \blacktriangleright .

The disc tray closes and the unit starts playing back the loaded disc.

- You can also close the disc tray by pressing \blacktriangle on the front panel.

By pressing the following buttons, you can stop, advance, or reverse playback, and locate the beginning of the title, chapter, or track.



On the front panel

From the remote control



To stop playback temporarily

Press II.

- Pressing \blacktriangleright starts playback again.

To move back the playback position by 10 seconds (for DVD VIDEO only)

Press \blacktriangleright during DVD VIDEO playback.

The unit moves the playback position about 10 seconds before the current position, then resumes playback.

To advance or reverse playback rapidly

Press and hold \blacktriangleright or \blacktriangleleft .

While you are pressing and holding \blacktriangleright (or \blacktriangleleft), the unit advances (or reverses: for DVD VIDEO and audio CD) playback 5 times as fast as the normal speed. When you press and hold \blacktriangleright (or \blacktriangleleft) further, the playback speed changes up to 20 times as fast as the normal speed.

- Releasing the button resumes the normal playback.

To locate the beginning of the chapter, or track

Press \blacktriangleright or \blacktriangleleft .

Press \blacktriangleright (or \blacktriangleleft) to locate the beginning of the next (current or previous) chapter, or track.

To locate the chapter or track using number buttons

Press number buttons (1–10, +10) to select the number of the desired chapter or track.

Ex. : To select 3, press 3.

To select 11, press +10, then 1.

To select 20, press +10, then 10.

From the remote control ONLY

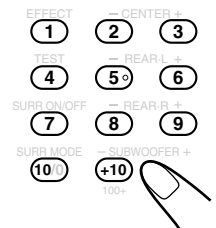

About indication on the display while playing back a disc

While you are playing back a disc, the playback information appears on the display as follows:

Ex. : When DVD VIDEO is loaded



Ex. : When audio CD is loaded

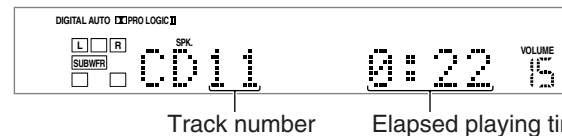

4 Adjust the Volume

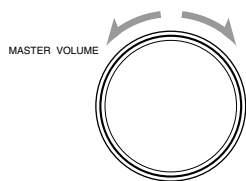

On the front panel



From the remote control

For details, see “Basic Operations” on page 11.

5 Activate Realistic Sound Field

You can activate Surround mode for making realistic sound field.

- You can activate Surround mode automatically when the digital multichannel source (Dolby Digital or DTS Digital Surround software), or 2-channel matrix source (Dolby Surround software) is played back—Auto Surround (see page 22).

When you activate or deactivate Surround mode manually, do the following procedures:

On the front panel:
Press **SURROUND ON/OFF**.



From the remote control:

1) Press **SOUND**.

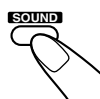

2) Press **SURR ON/OFF**.



- Each time you press SURROUND ON/OFF on the front panel or SURR ON/OFF on the remote control, Surround mode is activated and deactivated alternately.

6 Select Surround Mode

When the **PRO LOGIC II** or **DSP** indicator is lit, you can select various Surround modes (see page 27).



On the front panel



From the remote control

Press **SURROUND MODE (REC MODE)** on the front panel or **SURR MODE** on the remote control.

- When you enjoy digital multichannel source such as Dolby Digital or DTS Digital Surround software, you cannot change Surround mode. When you enjoy Dolby Digital or DTS Digital Surround 2-channel including 2-channel matrix source such as Dolby Surround software, you can select Surround mode from between PRO LOGIC II MOVIE and PRO LOGIC II MUSIC (see page 27).

7 Stop Playback



On the front panel



From the remote control

Press **■**.

Playback stops.

The unit memorizes the point where you stop playback and the RESUME indicator lights up on the display (except when an audio CD is loaded).

While the RESUME indicator is lit on the display, you can start playback from the memorized point by pressing **▶**—Resume play.

About Resume play

This unit can memorize the point when you operate the following procedures:

- Pressing **■** during playback—Pressing **▶** starts Resume play
- Changing the source—Pressing DVD or **▶** starts Resume play
- Turning off the unit (including Sleep Timer)
—Pressing **▶** starts Resume play

Once you start Resume play, the RESUME indicator goes off (the unit clears the memorized point).

The unit also clears the memorized point when you operate the following procedures:

- Starting Resume play
- Pressing **■** (while the RESUME indicator is lit on the display)
- Selecting a track by pressing **▶▶** or **◀◀** for video CD and super VCD when playback stops
- Selecting program or random playback
- Pressing TOP MENU
- Ejecting the loaded disc
- Turning on the unit by pressing **⏻**/STANDBY/ON on the front panel or **⏻**/STANDBY/ON AUDIO on the remote control.

You can cancel Resume play (see “OTHERS menu” on page 52).

To remove the loaded disc

Press **▲**.

The disc tray opens.

To close the disc tray

Press **▲** again.

8 Turn Off the Power (into Standby)

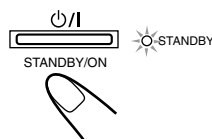

On the front panel

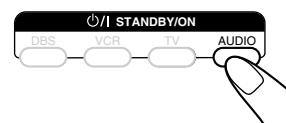

From the remote control

Press **⏻**/STANDBY/ON on the front panel or **⏻**/STANDBY/ON AUDIO on the remote control.

The unit is turned off and the STANDBY lamp lights up on the front panel.

- If you press the button while the disc tray is open, the disc tray closes automatically, then the unit is turned off.
- A small amount of power is consumed even in standby mode. To turn the power off completely, unplug the AC power cord.

Tuner Operations

Tuning into Stations Manually

On the front panel:

1 Press FM/AM to select the band.

The last received station of the selected band is tuned in.

The CONTROL buttons now work for tuner operations.

- Each time you press the button, the band alternates between FM and AM.



Ex. : When selecting the FM band

2 Press CONTROL ▼ (or ▲) repeatedly until “< TUNING >” appears on the display.



3 While “< TUNING >” still remains on the display, press repeatedly or hold CONTROL ► (or ◀) until you find the frequency you want.



- Pressing (or holding) CONTROL ► increases the frequencies.
- Pressing (or holding) CONTROL ◀ decreases the frequencies.

From the remote control:

1 Press FM/AM.

2 Press repeatedly or hold TUNING ⊕ or ⊖ until you find the frequency you want.

- Pressing (or holding) TUNING ⊕ increases the frequencies.
- Pressing (or holding) TUNING ⊖ decreases the frequencies.

Notes:

- When you hold and release CONTROL ► (or TUNING ⊕ on the remote control) or CONTROL ◀ (or TUNING ⊖ on the remote control), the frequency keeps changing until a certain station is tuned in.
- When a station of sufficient signal strength is tuned in, the TUNED indicator lights up on the display.
- When an FM stereo program is received, the STEREO indicator also lights up.

Using Preset Tuning

Once a station is assigned to a channel number, the station can be quickly tuned. You can preset up to 30 FM and 15 AM stations.

To store the preset stations

Before you start, remember...

There is a time limit in doing the following steps.

If the setting is canceled before you finish, start from step 2 again.

On the front panel ONLY:

1 Tune into the station you want to preset (see “Tuning into Stations Manually”).

- If you want to store the FM reception mode for this station, select the FM reception mode you want. See “Selecting the FM Reception Mode” on page 18.



Ex. : When selecting the FM band

2 Press MEMORY.

The channel number position starts flashing on the display for about 5 seconds.



3 Press CONTROL ► (or ◀) to select a channel number while the channel number position is flashing.



4 Press MEMORY again while the selected channel number is flashing on the display.

The station is assigned to the selected channel number.

- The selected channel number stops flashing and then the frequency starts flashing.



5 Press CONTROL ► (or ◀) to select another frequency you want to store while the frequency is flashing on the display.

6 Repeat steps 2 to 5 until you store all the stations you want.

To erase a stored preset station

Storing a new station on a used channel number erases the previously stored one.

■ To tune in a preset station

On the front panel:

1 Press FM/AM to select the band.

The last received station of the selected band is tuned in, and the CONTROL buttons now work for tuner operations.

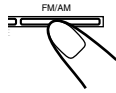

Ex.: When selecting the FM band

2 Press CONTROL ▼ (or ▲) repeatedly until “< PRESET >” appears on the display.

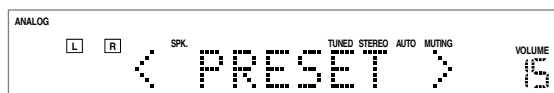
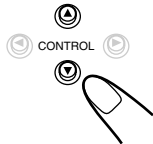

3 While “< PRESET >” still remains on the display, press CONTROL ► (or ◀) to select a preset channel number you want.

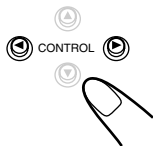

- Pressing (or holding) CONTROL ► increases the preset channel numbers.
- Pressing (or holding) CONTROL ◀ decreases the preset channel numbers.

From the remote control:

1 Press FM/AM.

The last received station of the selected band is tuned in. The number buttons now work for tuner operations.

- #### 2 Press number buttons to select a preset channel number.
- For channel number 5, press 5.
 - For channel number 15, press +10 then 5.
 - For channel number 30, press +10, +10, then 10.

Selecting the FM Reception Mode

When an FM stereo broadcast is hard to receive or noisy, you can change the FM reception mode while receiving an FM broadcast.

- You can store the FM reception mode for each preset station.

Before you start, remember...

There is a time limit in doing the following steps.

If the setting is canceled before you finish, start from step 1 again.

On the front panel:

1 While listening to an FM station, press CONTROL ▼ (or ▲) repeatedly until “< FM MODE >” appears on the display.

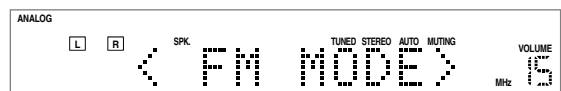
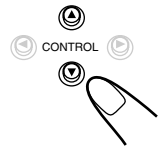

2 While “< FM MODE >” still remains on the display, press CONTROL ► (or ◀) to select “MONO.”

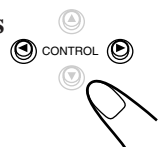

- Each time you press the button, the FM reception mode alternates between “AUTO MUTING”* and “MONO.”

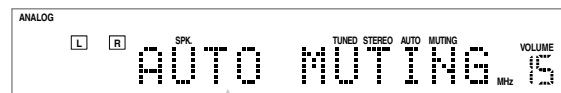

AUTO MUTING ↔ MONO

- * “AUTO MUTING” is the initial setting. If you have already changed the setting, “MONO” will be shown.

AUTO MUTING: Normally select this.

When a program is broadcasted in stereo, you will hear stereo sound; when in monaural, you will hear monaural sounds. This mode is also useful to suppress static noise between stations. The AUTO MUTING indicator lights up on the display.

MONO

: Select this to improve the reception (but stereo effect will be lost).

In this mode, you will hear noise while tuning into the stations. The AUTO MUTING indicator goes off from the display. (The STEREO indicator also goes off.)

To restore the stereo effect

Repeat step 1, then select “AUTO MUTING” in step 2.

From the remote control:

1 Press FM/AM to select an FM station.

Number buttons now work for tuner operations.

2 Press FM MODE.

- Each time you press the button, the FM reception mode alternates between “AUTO MUTING” and “MONO.”

Basic Settings

Some of the following settings are required after connecting and positioning your speakers, while others will make operations easier. You can set the items by using the SETTING button and CONTROL ▲/▼/◀/▶ buttons on the front panel.

Setting items:

- Digital input (DIGITAL IN) terminals
- Speakers information for front, center, rear speakers, and subwoofer*
- Speakers distance for front, center, and rear speakers*
- Crossover frequency*
- Low frequency effect attenuator*
- Dynamic range compression*
- Auto surround
- Video output mode

Note:

* You can also set these items using the Choice menu (see pages 47 to 52).

Operation Buttons

To do the basic settings for this unit, use the buttons on the front panel.



| Button | To do |
|-------------|---|
| SETTING | display the setting indications on the display* |
| CONTROL ▲/▼ | select an item on the display Each time you press the button, the indication changes as illustrated below. |
| CONTROL ▶/◀ | adjust the selected item |

• When no operation is done for about 5 seconds, the indications on the display will disappear.

* Pressing SETTING repeatedly also changes the indication.

Configuration of the indications on the display

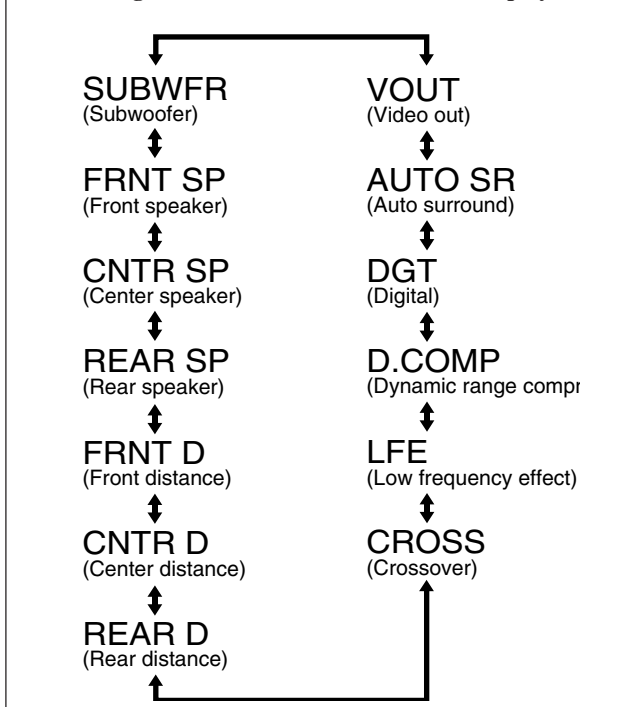

Operating Procedure

Ex. : When setting the digital input (DIGITAL IN) terminals.

Before you start, remember...

There is a time limit in doing the following steps. If the setting is canceled before you finish, start from step 1 again.

1 Press SETTING.

The CONTROL buttons now work for basic settings. The setting item selected previously appears on the display.

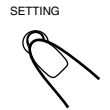

2 Press CONTROL ▼ (or ▲) repeatedly until “DGT (Digital)” (with the current setting)* appears on the display.

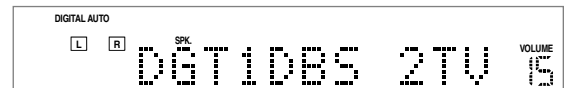
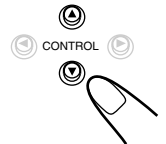

* “1DBS 2TV” is the initial setting. If you have already changed the setting, another combination will be shown.

3 Press CONTROL ▶ (or ◀) to select the appropriate digital terminal setting.

• Each time you press the button, the indication changes as follows:

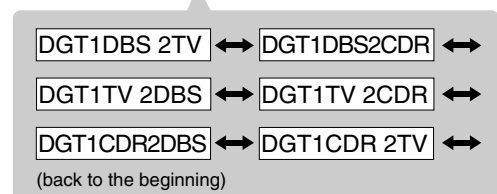
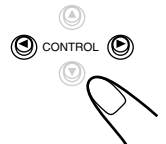

■ **Speaker information—“SUBWFR (subwoofer),” “FRNT SP (front speaker),” “CNTR SP (center speaker),” and “REAR SP (speaker)”**

To obtain the best possible effect from the Surround modes (see pages 25 to 28), register the following information after all connections are completed.

● **For subwoofer:**



Select one of the following settings:

- YES** : Select this when a subwoofer is connected.
NO : Select this when no subwoofer is used.

Notes:

- “NO” is the initial setting.
- If you have selected “NO” for the subwoofer, you can only select “LARGE” for the front speakers.

● **For front speakers, center speaker, and rear speakers:**

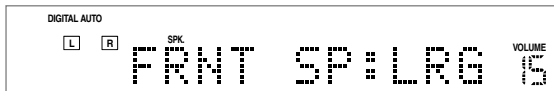

Select one of the following settings for each speaker:

- LRG (large)** : Select this when the speaker size is relatively large.
SML (small) : Select this when the speaker size is relatively small.
NO : Select this when you have not connected a speaker. (Not selectable for the front speakers)

Notes:

- “LRG (large)” is the initial setting for the front speakers, “SML (small)” for the center and rear speakers.
- Keep the following comment in mind as reference when adjusting the settings.
 - If the size of the cone speaker unit built in your speaker is greater than 4 3/4 inches (12 cm), select “LRG (large),” and if it is smaller than 4 3/4 inches (12 cm), select “SML (small).”
- If you have selected “SML (small)” for the front speakers, you cannot select “LRG (large)” for the center and rear speakers.

■ **Speaker distance—“FRNT D (front distance),” “CNTR D (center distance),” and “REAR D (distance)”**



The distance from your listening point to the speakers is another important element to obtain the best possible surround sound of the Surround modes.

You need to set the distance from your listening point to the speakers. By referring to the speaker distance setting, this unit automatically sets the delay time of the sound through each speaker so that sounds through all the speakers can reach you at the same time.

Set the distance from the listening point within the range of 1 ft (0.3 m) to 30 ft (9.0 m), in 1 ft (0.3m) interval.

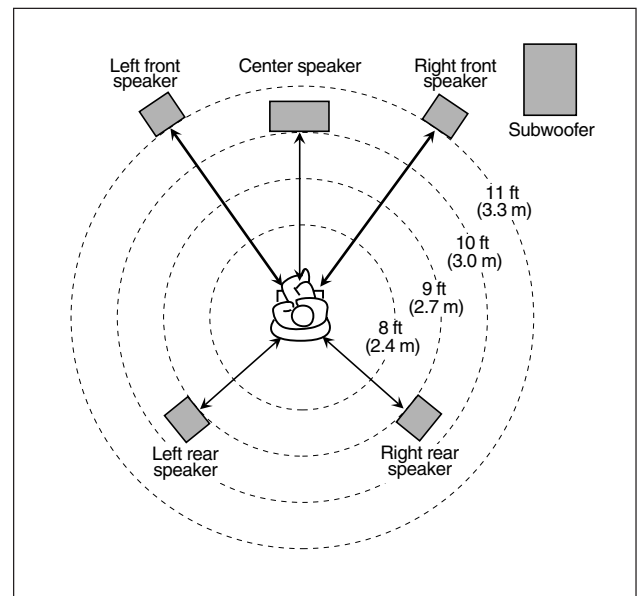

Ex. : In this case,
 set “FRNT D” to “11ft,”
 set “CNTR D” to “10ft” and
 set “REAR D” to “9ft.”

Notes:

- “10ft” is the initial setting. If you have already changed the setting, another setting will be shown.
- If you have selected “NO” for the center and rear speakers setting, you cannot set the speaker distance for the center and rear speakers.

Basic Settings

■ Crossover frequency—“CROSS (crossover)”

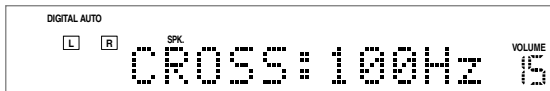

Small speakers cannot reproduce the bass sounds efficiently. If you use a small speaker in any position, this unit automatically reallocates the bass sound elements assigned to the small speaker to the large speakers.

To use this function properly, set the crossover frequency level according to the size of the small speaker connected.

- If you have selected “LRG (large)” for all speakers, this function will not take effect.

Select one of the following settings:

- | | |
|--------------|--|
| 80Hz | : Select this frequency when the cone speaker unit built in the speaker is about 4 ³ / ₄ inches (12 cm). |
| 100Hz | : Select this frequency when the cone speaker unit built in the speaker is about 3 ¹⁵ / ₁₆ inches (10 cm). |
| 120Hz | : Select this frequency when the cone speaker unit built in the speaker is about 3 ³ / ₁₆ inches (8 cm). |
| 150Hz | : Select this frequency when the cone speaker unit built in the speaker is about 2 ³ / ₈ inches (6 cm). |
| 200Hz | : Select this frequency when the cone speaker unit built in the speaker is less than 2 inches (5 cm). |

Notes:

- “100Hz” is the initial setting. If you have already changed the setting, another frequency will be shown.
- Crossover frequency is not valid for the HEADPHONE mode.

■ Low frequency effect attenuator—“LFE”



If the bass sound is distorted while playing back software encoded with **Dolby Digital** or **DTS Digital Surround**, set the LFE level to eliminate distortion.

- This function takes effect only when the LFE (subwoofer) signals come in.

Select one of the following settings:

- | | |
|--------------|---|
| 0dB | : Normally select this. |
| -10dB | : Select this when the bass sound is distorted. |

Note:

- “0dB” is the initial setting. If you have already changed the setting, “-10dB” will be shown.

■ Dynamic range compression—“D.COMP”



You can compress the dynamic range (difference between maximum sound and minimum sound) of the reproduced sound. This is useful when enjoying surround sound at night.

- This function takes effect only when playing back a source encoded with **Dolby Digital**.

Select one of the following settings:

- | | |
|------------|---|
| OFF | : Select this when you want to enjoy surround with its full dynamic range. (No effect applied.) |
| MID | : Select this when you want to reduce the dynamic range a little. |
| MAX | : Select this when you want to apply the compression effect fully. (Useful at night.) |

Note:

- “MID” is the initial setting. If you have already changed the setting, another setting will be shown.

■ Digital input (DIGITAL IN) terminals—“DGT”



When you use the digital input terminals, register what components are connected to which terminals (DIGITAL IN 1/ DIGITAL IN 2). So, the correct source name will appear when you select the digital source.

Set the appropriate digital terminal setting.

- Each time you press CONTROL ► or ◀, the display changes as follows:

1 DBS 2 TV ⇄ 1 DBS 2 CDR ⇄ 1 TV 2 DBS ⇄
1 TV 2 CDR ⇄ 1 CDR 2 DBS ⇄ 1 CDR 2 TV ⇄
(back to the beginning)

Notes:

- “1DBS 2TV” is the initial setting. If you have already changed the setting, another combination will be shown.
- If you want to connect a CD recorder to the digital input terminal, change the source name to “CDR” from “TAPE.” For details, see “Changing the Source Name” on page 12.

■ Auto surround—“AUTO SR”



Surround mode is automatically activated when digital multichannel source such as Dolby Digital or DTS Digital Surround software or 2-channel matrix source such as Dolby Surround is played back.

You can enjoy Surround mode simply by selecting the source (with digital input selected for that source)—Auto Surround.

Select one of the following settings:

- ON** : The AUTO SURROUND indicator always lights up on the display.
- If multichannel signals come in, an appropriate Surround mode will be turned on.
 - If Dolby Digital 2-channel or DTS 2-channel including surround signals come in, “PL II MOVIE” will be selected.
 - If Dolby Digital 2-channel or DTS 2-channel signals without surround signals come in, “STEREO” will be selected.
 - If the other signals come in, nothing will change.
- OFF** : Select this to deactivate Auto Surround.

Notes:

- “ON” is the initial setting. If you have already changed the setting, “OFF” will be shown.
- This function does not take effect in the following cases:
 - While playing an analog source.
 - While selecting “DGTL D.D.” or “DGTL DTS” as the fixed digital input mode (see page 13).
- If you press SURROUND ON/OFF (SURR ON/OFF on the remote control) with Auto Surround activated, Auto Surround will be canceled temporarily for the currently selected source. Auto Surround setting will be restored in the following cases:
 - When you turn off and on the unit,
 - When you change the source,
 - When you change the analog/digital input, and
 - When you reset “AUTO SR” to “ON” again.

■ Video output mode—“VOUT”

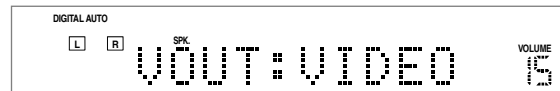

After connecting your TV to the unit, register the type of the connected output terminal—VIDEO, S-VIDEO, or DVD COMPONENT VIDEO OUT.

Without setting this, AV COMPU LINK does not work appropriately when DVD is selected as the source (see “AV COMPU LINK Remote Control System” on pages 57 and 58).

Set the output terminal appropriately.

- VIDEO** : Select this when you connect your TV to VIDEO jack by using a composite video cord.
- S** : Select this when you connect your TV to S-VIDEO jack by using an S-video cord.
- COMPNT** : Select this when you connect your TV to DVD COMPONENT VIDEO OUT jacks by using component video cord.

Note:

- “VIDEO” is the initial setting. If you have already changed the setting, another setting will be shown.

Sound Adjustments

The following settings are required after connecting and positioning your speakers.

You can adjust the items by using the ADJUST button and CONTROL ▲/▼/◀/▶ buttons on the front panel.

Adjustment items:

- Front speakers output balance*
- DAP effect level
- Tone*
- Speaker output level*

Notes:

- The setting contents of adjustment items are memorized for each source.
- * You can also set these items using the Choice menu (see pages 47 to 52).

Operation Buttons

To do the basic settings for this unit, use the buttons on the front panel.



On the front panel ONLY*

| Button | To do |
|-------------|---|
| ADJUST | display the adjustment indications on the display** |
| CONTROL ▲/▼ | select an item on the display Each time you press the button, the indication changes as illustrated below. |
| CONTROL ▶/◀ | adjust the selected item |

- When no operation is done for about 5 seconds, the indications on the display will disappear.
- * You can also make sound adjustment except for front speakers output balance from the remote control.
- ** Pressing ADJUST repeatedly also changes the indication.

Configuration of the indications on the display

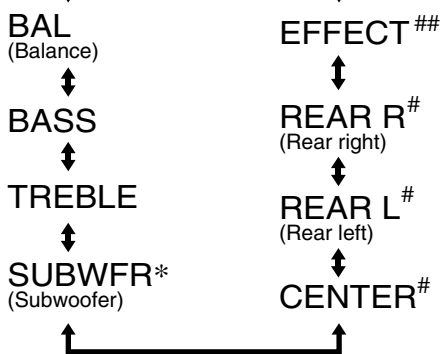

These indications appear only when the corresponding speakers information for each speaker is set to other than "NO."

"EFFECT" appears only when one of DAP modes (see pages 25 to 28) is activated.

Operating Procedure

Ex. : When setting the front speaker output balance.

Before you start, remember...

There is a time limit in doing the following steps. If the setting is canceled before you finish, start from step 1 again.

1 Press ADJUST.

The CONTROL buttons now work for sound adjustments. The setting item selected previously appears on the display.



2 Press CONTROL ▼ (or ▲) repeatedly until "BAL (Balance)" (with the current setting)* appears on the display.

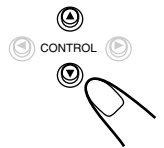

* "CENTER" is the initial setting. If you have already changed the setting, another setting will be shown.

3 Press CONTROL ▶ (or ◀) to adjust the front speaker balance.

• Each time you press the button, the indication changes as follows:

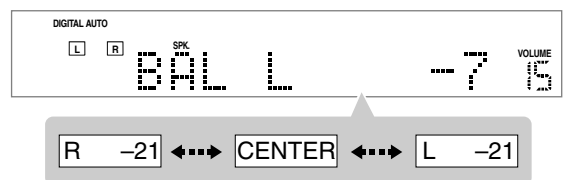
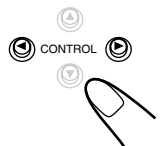

■ Front speaker output balance —“BAL (balance)”



If the sounds you hear from the front right and left speakers are unequal, you can adjust the speaker output balance.

Adjust the output balance appropriately from the listening point within the range of R (Right) –21 to CENTER (0) or CENTER (0) to L (Left) –21.

Note:

- “CENTER” is the initial setting. If you have already changed the setting, another setting will be shown.

■ Tone—“BASS” and “TREBLE”



You can adjust the bass and treble sounds as you like.

Adjust the tone within the range of –10 to +10 in 2 steps intervals.

Note:

- “0” is the initial setting. If you have already changed the setting, another setting will be shown.

Adjusting sound from the remote control

1 Press SOUND.

Number buttons now work for sound adjustments.

2 Adjust the level as follows:

To adjust subwoofer, press SUBWOOFER + or –.

To adjust center speaker, press CENTER + or –.

To adjust left rear speaker, press REAR•L + or –.

To adjust right rear speaker, press REAR•R + or –.

To adjust the effect level (for DAP mode), press EFFECT.

■ Speaker output levels—“SUBWFR,” “CENTER,” “REAR L (left),” and “REAR R (right)”

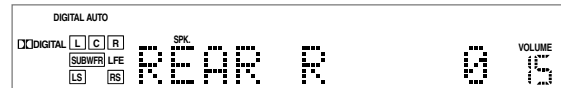

You can adjust the speaker output levels if you have set the speaker information appropriately.

- You can adjust the output level for center and/or rear speakers only when one of proper Surround modes is activated (see page 27).

Adjust the speaker output level within the range of –10 to +10.

Note:

- “0” is the initial setting. If you have already changed the setting, another setting will be shown.

■ DAP effect level—“EFFECT”



While one of DAP modes is activated (the DSP indicator lights up on the display), you can adjust the effect level. For details about DAP modes, see pages 25 to 28.

Adjust the effect level within the range of 1 to 5.

Note:

- “3” is the initial settings. If you have already changed the setting, another setting will be shown.

About auto memory

This unit memorizes the settings for each source:

- when you turn off the power (see page 11),
- when you change the source (see page 11),
- when you change the source name (see page 12), and
- when you change the analog/digital input mode (see page 13).

When you change the source, the memorized settings for the newly selected source are automatically recalled.

The following can be stored for each source:

- Analog/digital input mode (see page 13)
- Input attenuator mode (see page 14)
- Front speaker output balance (see above or page 50)
- Speaker output level (see above or page 51)
- Tone adjustment (see above or page 50)
- DAP effect level (see above)
- Surround mode selection (see page 27)

Note:

- If the source is FM or AM, you can assign a different setting for each band.

Creating Realistic Sound Fields

You can use the following Surround modes to reproduce a realistic sound field:

- **Dolby Surround**
 - Dolby Pro Logic II
 - Dolby Digital
- **DTS Digital Surround**
- **DAP (Digital Acoustic Processor) modes**
- **All Channel Stereo**

■ Dolby Surround

Dolby Pro Logic II*

Dolby Pro Logic II has newly developed multichannel playback format to decode into 5.1-channel from all 2-channel sources—stereo source and Dolby Digital encoded source.

Matrix-based encoding/decoding method for Dolby Pro Logic II makes no limitation for the cutoff frequency of the rear treble and enables stereo rear sound compared to conventional Dolby Pro Logic.

Dolby Pro Logic II enables to reproduce spacious sound from original sound without adding any new sounds and tonal colorations. Dolby Pro Logic II has two modes—**Movie mode** and **Music mode**:

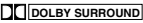
Pro Logic II Movie (PL II MOVIE)—suitable for reproduction of Dolby Surround encoded sources bearing the mark  and stereo television sources. You can enjoy sound field very close to the one created with discrete 5.1-channel sounds.

Pro Logic II Music (PL II MUSIC)—suitable for reproduction of any 2-channel stereo music sources. You can enjoy wide and deep sound by using this mode.

- When Dolby Pro Logic II is activated, the  PRO LOGIC II indicator lights up on the display.

Dolby Digital*

Used to reproduce multichannel sound tracks of the software encoded with Dolby Digital ().

- To enjoy the software encoded with Dolby Digital, connect the source component using the digital terminal on the rear of this unit. (See page 10.)

Dolby Digital 5.1-channel encoding method (so-called discrete multichannel digital audio format) records and digitally compresses the left front channel, right front channel, center channel, left rear channel, right rear channel, and LFE channel signals.

Since each channel is completely independent from the other channel signals to avoid interference, you can obtain much better sound quality with much stereo and surround effects.

Note:

- *Dolby Digital or DTS software can be roughly grouped into two categories—multichannel (up to 5.1-channel) and 2-channel software. To enjoy surround sounds while playing Dolby Digital 2-channel or DTS software, you can use Dolby Pro Logic II.*

■ DTS Digital Surround**

Used to reproduce multichannel sound tracks of the software encoded with DTS Digital Surround ().

- To enjoy the software encoded with DTS Digital Surround, connect the source component using the digital terminal on the rear of this unit. (See page 10.)

DTS Digital Surround is another discrete multichannel digital audio format available on CD, LD, and DVD software.

Compared to Dolby Digital, audio compression ratio is relatively low. This fact allows DTS Digital Surround format to add breadth and depth to the reproduced sounds. As a result, DTS Digital Surround features natural, solid and clear sound.

Typical Multichannel (5.1-channel) reproduction

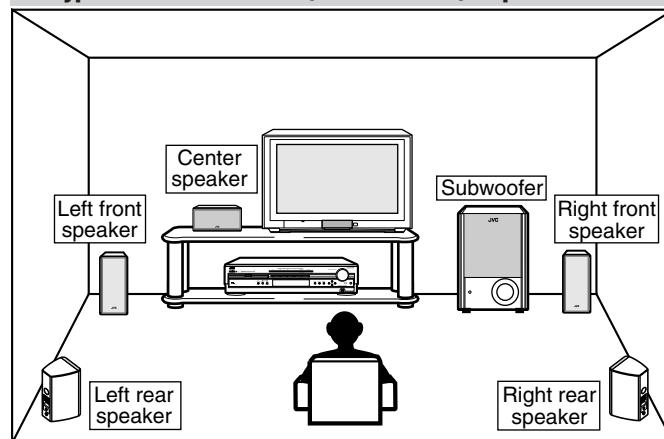

■ DAP (Digital Acoustic Processor) modes

DAP modes have been designed to create important acoustic surround elements.

The sound heard in a live club, dance club, hall or pavilion consists of direct sound and indirect sound—early reflections and reflections from behind. Direct sounds reach the listener directly without any reflection. On the other hand, indirect sounds are delayed by the distances of the ceiling and walls (see the diagram below).

These indirect sounds are important elements of the acoustic surround effects. The DAP mode can reproduce a realistic sound field by adding these indirect sounds.

DAP modes can be used when the front and rear speakers are connected to this unit (without respect to the center speaker connection: no sound comes out of the center speaker even if it is connected).

* Manufactured under license from Dolby Laboratories. "Dolby," "Pro Logic," and the double-D symbol are trademarks of Dolby Laboratories.

** Manufactured under license from Digital Theater Systems, Inc. US PAT. No. 5,451,942 and other world-wide patents issued and pending. "DTS" and "DTS Digital Surround" are trademarks of Digital Theater Systems, Inc. Copyright 1996 Digital Theater Systems, Inc. All rights reserved.

The following DAP modes are provided for this unit:

| | |
|-------------------|---|
| LIVE CLUB | : Gives the feeling of a live music club with a low ceiling. |
| DANCE CLUB | : Gives a throbbing bass beat. |
| HALL | : Gives clear vocal and the feeling of a concert hall. |
| PAVILION | : Gives the spacious feeling of a pavilion with a high ceiling. |

These DAP modes can be used to add the acoustic surround effects while reproducing 2-channel stereo software, either analog or Linear PCM digital signal, and can give you a real “being there” feeling.

- When one of the DAP modes is selected, the DSP indicator lights up on the display.

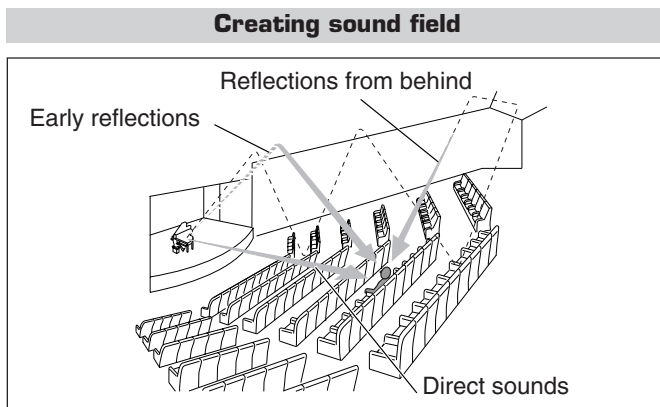

■ All Channel Stereo

This mode can reproduce a larger stereo sound field using all the connected (and activated) speakers.

All Channel Stereo can be used when the front and rear speakers are connected to this receiver without respect to the center speaker connection.

If the center speaker is connected and activated, the same phases of the front left and right signals are mixed and output through the center speaker.

All Channel Stereo can be used while reproducing 2-channel stereo software, either analog or Linear PCM digital signal.

- When All Channel Stereo is selected, the DSP indicator lights up on the display.

All Channel Stereo reproduction

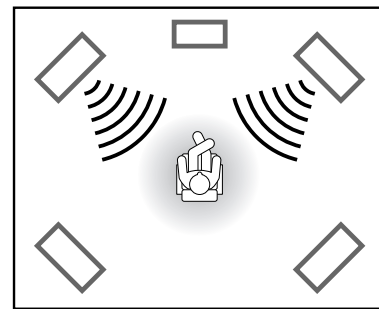

Sound reproduced from normal stereo

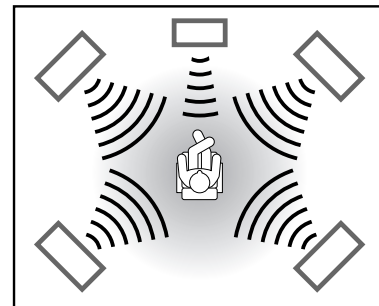

Sound reproduced from All Channel Stereo

Available Surround modes for each input signal

○: Possible ×: Impossible

| Modes Signals | STEREO | DOLBY DIGITAL | DTS SURROUND | PL II MOVIE | PL II MUSIC | LIVE CLUB | DANCE CLUB | HALL | PAVILION | ALL CH ST. |
|---|--------|------------------|-----------------|----------------|----------------|--------------|---------------|------|----------|---------------|
| Dolby Digital (Multichannel) | ○ | ○ | × | × | × | × | × | × | × | × |
| Dolby Digital (2-channel) | ○ | × | × | ○ | ○ | × | × | × | × | × |
| Dolby Surround (matrix 2-ch) | ○ | × | × | ○ | ○ | × | × | × | × | × |
| DTS Digital Surround (Multichannel) | ○ | × | ○ | × | × | × | × | × | × | × |
| DTS Digital Surround (2-channel) | ○ | × | × | ○ | ○ | × | × | × | × | × |
| Linear PCM | ○ | × | × | ○ | ○ | ○ | ○ | ○ | ○ | ○ |
| Analog | ○ | × | × | ○ | ○ | ○ | ○ | ○ | ○ | ○ |

Creating Realistic Sound Fields

Activating Surround Mode

When Auto surround is set to “OFF” or 2-channel source other than Dolby Surround software is played back, activate Surround mode manually.

Make sure that you have set the speakers information correctly (see page 20 or 51).

- If only front speakers are connected, you cannot activate any Surround mode.

On the front panel:

Press SURROUND ON/OFF.

The SURROUND indicator lights up on the display (when Auto surround is set to “OFF”).

- Each time you press the button, Surround mode is activated and deactivated alternately.



From the remote control:

1 Press SOUND.

Number buttons now work for sound adjustments.

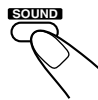

2 Press SURR ON/OFF.

The SURROUND indicator lights up on the display (when Auto surround is set to “OFF”).

- Each time you press the button, Surround mode is activated and deactivated alternately.



About SURROUND indicators

- When Auto surround is set to “ON,” the AUTO SURROUND indicator always lights up on the display.
- When you activate Surround mode manually with Auto surround set to “OFF,” the SURROUND indicator lights up on the display.

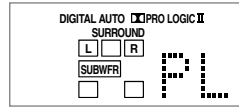
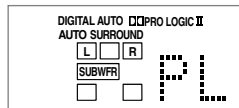

Selecting Surround Modes

When 2-channel source is played back with Surround mode activated, you can select another Surround mode.

Available Surround modes will vary depending on the number of the connected speakers and the playback sound.

Make sure that you have set the speaker information correctly (see page 20 or 51).

- If rear speakers are not connected, you cannot use DAP modes and the All Channel Stereo.

On the front panel:

Press SURROUND MODE.

- Each time you press the button, Surround mode is changed as illustrated below:



From the remote control:

1 Press SOUND.

Number buttons now work for sound adjustments.

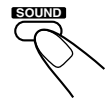

2 Press SURR MODE.

- Each time you press the button, Surround mode is changed as illustrated below:



When 5 or 4 (except center speaker) speakers are connected:

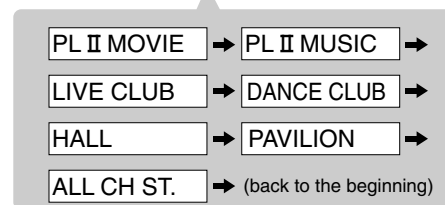

When 3 (except rear speakers) speakers are connected or Dolby Digital or DTS 2-channel including matrix source is played back:

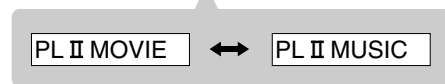

Signal and speaker indicators on the display

The following signal indicators light up —:

- L, R : •When digital input is selected: Light up when the signals corresponding to each channel come in.
•When analog input is selected: Always light up.
- C, LS, RS : Light up when the signals corresponding to each channel come in.
- S : Lights up when the monaural rear channel signal or Dolby Surround encoded signal comes in.
- LFE : Lights up when the LFE channel signal comes in.

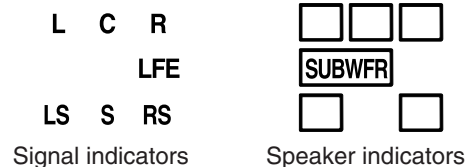

The speaker indicators light up as follows:

- The subwoofer speaker indicator (SUBWFR) lights up when “SUBWFR” is set to “YES” (see page 20) or “USE” (see page 51).
- The other speaker indicators light up only when the corresponding speaker is activated, and also when required for the current playback.

Adjusting Surround Mode Using Remote Control

When playing back the source with Surround mode, you can adjust the speaker output levels for Surround modes.

Once you have adjusted the Surround modes, the adjustment is memorized for each source.

- You can also adjust Surround modes using the Choice menu (see pages 47 to 52) or buttons on the front panel (see page 24).
- When using test tone, you can adjust the speaker output level without playback sounds.

1 Select and play back software you like.

2 Activate and select Surround mode.

- When 2-channel source is played back, you can select Surround modes.

3 Adjust the sound.

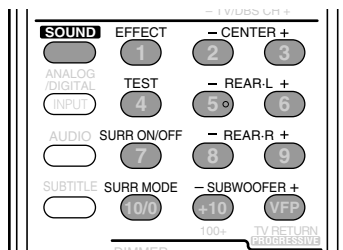

1) Press SOUND.

Number buttons now work for the sound adjustment.

If you do not want to use the test tone, go to step 3-3).

2) Press TEST.

Playback is stopped.

“TEST L” starts flashing on the display and a test tone comes out of the speakers in the following order:

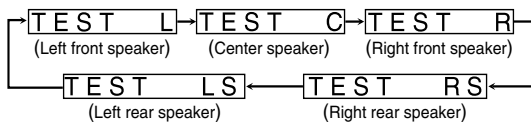

Notes:

- You can adjust the speaker output levels without the test tone.
- No test tone comes out of the speaker when its speaker information is set to “NO.”

3) Adjust the speaker output level as follows:

To adjust center speaker, press CENTER +/-.*

To adjust left rear speaker, press REAR•L +/-.

To adjust right rear speaker, press REAR•R +/-.

To adjust the effect level, press EFFECT.**

The name for the item currently adjusted appears on the display. For details, see the illustrations of “Speaker output level” on page 24.

Notes:

- You can adjust the speaker output level for the activated speakers ONLY (the speaker indicators are lit on the display).
- * You cannot adjust the output level of center speaker when one of DAP modes is activated.
- ** You can adjust the effect level only when one of DAP modes is activated.

4) Press TEST to stop the test tone.

The test tone stops.

- When no operation is done, the test tone stops automatically about 1 minute.

Note:

- Before operating the DVD player using remote control, press DVD to change the remote control operation mode to DVD.

Relation between Surround modes and adjustable items

○: Possible ×: Impossible

| Mode \ Item | TEST | CENTER | REAR•L | REAR•R | EFFECT |
|--------------------|------|--------|--------|--------|--------|
| Dolby Digital | ○ | ○ | ○ | ○ | × |
| DTS | ○ | ○ | ○ | ○ | × |
| Dolby Pro Logic II | ○ | ○ | ○ | ○ | × |
| DAP | ○ | × | ○ | ○ | ○ |
| All Channel Stereo | ○ | ○ | ○ | ○ | × |

Note:

- You cannot adjust the speakers which are not used by the selected Surround mode.

DVD Player Operations

Disc Information







■ Playable Disc Types

This unit has been designed to play back the following discs:

DVD VIDEO, Video CD (VCD), Super Video CD (SVCD), audio CD, CD-R, and CD-RW.

- This unit can also play back MP3 and JPEG files recorded on CD-R and CD-RW. For details about MP3, see “MP3 Disc Playback” on pages 43 and 44 and about JPEG, see “JPEG Disc Playback” on pages 45 and 46.
- This instruction refers to Video CD as VCD, Super Video CD as SVCD, and audio CD as CD.

Discs you can play:

| Disc Type | DVD VIDEO | VCD | SVCD | CD | CD-R | CD-RW |
|-------------|---|---|--|---|--|---|
| Mark (Logo) |  |  Video CD |   |  |  |  |

• The following discs cannot be played back:

DVD AUDIO, DVD-ROM, DVD-RAM, DVD-R, DVD-RW, CD-ROM, CD-I (CD-I Ready), Photo CD, etc.

Playing back these discs will generate noise and damage the speakers.

- On some DVD VIDEO, VCD, or SVCD, their actual operations may be different from what is explained in this manual. This is due to the disc programming and disc structure, but not a malfunction of this unit.

Note on Region Code

DVD players and DVD VIDEO have their own Region Code numbers. This unit can play back only DVD VIDEO recorded with the color system of NTSC whose Region Code numbers include “1.”

Ex. :



If a DVD VIDEO with the wrong Region Code numbers is loaded, “REGION CODE ERROR!” appears on the TV and playback cannot start.

IMPORTANT : Before playing a disc, make sure of the following...

- Check the connection with the TV.
- Turn on the TV and select the correct input mode on the TV to view the pictures or on-screen indications on the TV screen.
- For disc playback, you can change the initial setting to your preference. (See pages 47 to 55.)

If “⊗” appears on the TV screen when you press a button, the disc cannot accept an operation you have tried to do, or data required for that operation is not recorded on the disc.

NOTICE : In some cases, without showing “⊗”, operations will not be accepted.

Notes on CD-R and CD-RW

- User-edited CD-R (Recordable) and CD-RW (ReWritable) can be played back only if they are already “**finalized**.”
- The unit can play back CD-R or CD-RW recorded on a personal computer if they have been recorded in the **audio CD format**.

The unit can also play back CD-R or CD-RW if MP3 files or JPEG files are recorded on them.

However, they may not be played back because of their disc characteristics, recording conditions, or damage or stain on them. Especially, the configuration and characteristics of an MP3 disc or a JPEG disc is determined by the writing (encoding) software and hardware used for recording. Therefore, due to the software and hardware used, the following symptoms may occur:

- Some discs may not be played back.
- Some tracks on an MP3 disc are skipped and may not be played back normally.
- Some files on a JPEG disc may be played back distortedly.
- Before playing back CD-R or CD-RW, read their instructions or cautions carefully.
- CD-RW may require a longer readout time. It is caused by the fact that the reflectance of CD-RW is lower than for regular audio CD.

■ Disc structure

DVD VIDEO consists of “titles,” and each title may be divided into some “chapters” (see Example 1).

For example, if DVD VIDEO contains some movies, each movie may have its own **title** number, and it may be further divided into some **chapters**. In DVD VIDEO Karaoke, each song may have its own **title** number, but it may not be further divided into **chapters**.

VCD, SVCD, and CD consist of “tracks” (see Example 2).

In general, each track has its own **track** number. (On some discs, each track may also be divided by Indexes. This unit is not compatible with Index function.)

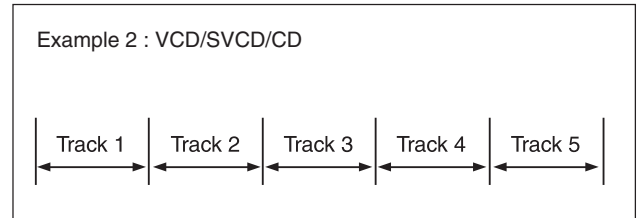
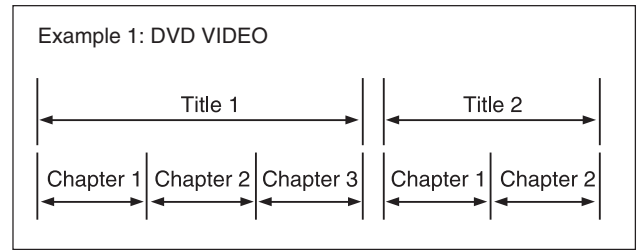

■ Playback Control function (PBC)

The Playback Control function allows you to enjoy menu-driven operation.

Menu-driven playback

A selection menu is displayed when you start playing VCD and SVCD with the Playback Control feature. The selection menu shows a list of numbers for selection. Some discs may show moving pictures or a divided screen.

You can interact with the screen using a menu display to select and play an entry.

See the example illustration on the right about basic feature of menu-driven playback (for details about the operation through the menu, see also page 33).

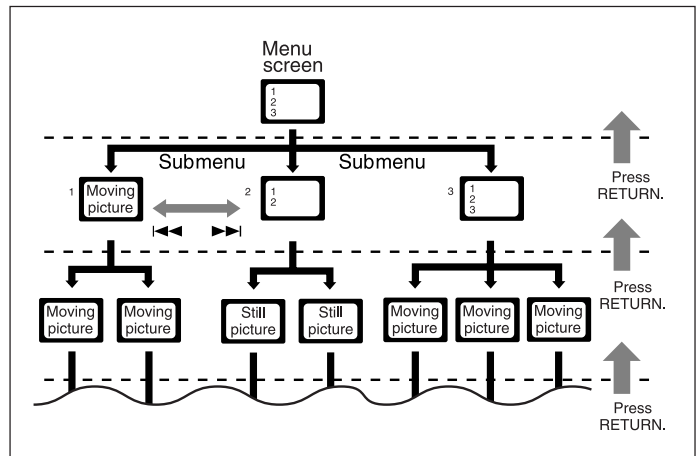





Note:

- While operating VCD or SVCD using the menu, some of the functions such as repeat play may not work.

DVD Player Operations

This section explains advanced operations of the built-in DVD player using the remote control. For MP3 playback, see pages 43 and 44, and for JPEG playback, see pages 45 and 46.

Before using the remote control, press DVD to change the remote control operation mode.

- See also “Basic DVD Player Operations” on pages 15 and 16.
-     show which types of disc are available for the operation.
- Turn on your TV, and select the correct input mode on the TV.

If “” appears on the TV when you press a button, the disc cannot accept an operation you have tried to do, or data required for that operation is not recorded on the disc.

Using the On-screen Bar

You can check the information of a disc while the disc is loaded and use some functions through the on-screen bar.



Press ON SCREEN.



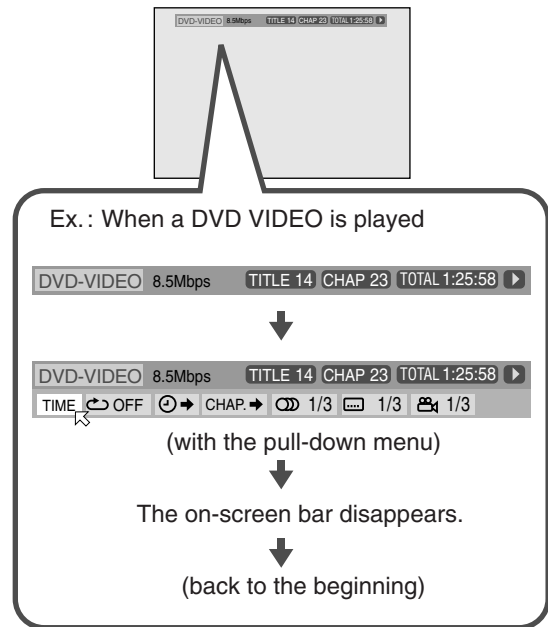

- Each time you press the button, the on-screen bar changes as shown to the right:

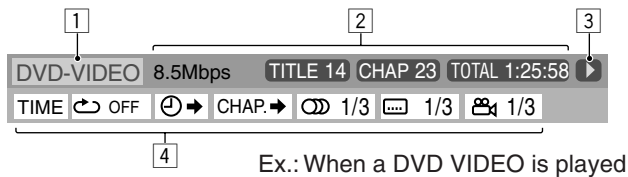





Contents of the on-screen bar with the pull-down menu





















- 1 Disc type**
- 2 Playback information**

| Indications | Meanings | Available discs |
|----------------------|--|---|
| Mbps | shows the current transfer rate (Megabits per second). |  |
| TITLE 14 | shows the current title. | |
| CHAP 23 | shows the current chapter. | |
| TRACK 14 | shows the current track. |    |
| TOTAL 1:25:58 | shows the elapsed playing time. | All discs |

- 3 Playback conditions for all types of disc**

| Indications | Meanings |
|---|-----------------------------|
|  | Playback |
|  | Fast forward/Fast reverse |
|  | Forward/reverse slow-motion |
|  | Pause |
|  | Stop |

- 4 Operation icons (on the pull-down menu)**

| Indications | Meanings | Available discs |
|---|---|---|
|  | Select this to change the time indication. See page 32. | All discs |
|  | Select this to repeat playback. See page 42. | |
|  | Select this for time search. See page 37. | |
|  | Select this for chapter search. See page 37. |  |
|  | Select this to change the audio language or channel. See pages 35 and 36. |    |
|  | Select this to change subtitle language. See page 35. |   |
|  | Select this to change the view angle. See page 34. |  |
|  | Select this for the program play. See page 41. |    |
|  | Select this for the random play. See page 41. | |

Basic Operation through the On-screen Bar

Ex. : When selecting the repeat mode for DVD VIDEO

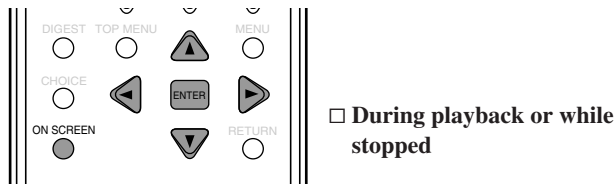

1 Press ON SCREEN twice.

The on-screen bar with pull-down menu appears on the TV.



2 Press cursor ► (or ◀) repeatedly to move to **TIME** on the pull-down menu.



3 Press ENTER.

The pop-up window appears under the pull-down menu.



4 Press cursor ▼ (or ▲) to select the desired option in the pop-up window.

• Each time you press the button, the options change.



5 Press ENTER.

The setting changes and the pop-up window goes off.



To turn off the on-screen bar

Press ON SCREEN.

Note:

• See the pages for the detail of each function.

Changing the Time Indication

You can change the time information in the on-screen bar and the display window on the center unit.

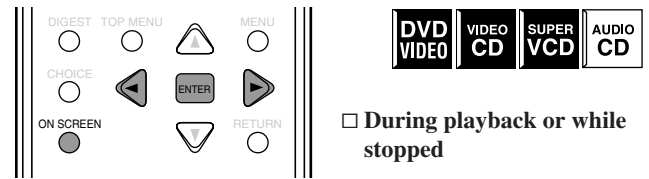

1 Press ON SCREEN twice.

The on-screen bar appears on the TV.

2 Press cursor ► (or ◀) to move to **TIME**.

3 Press ENTER.

• Each time you press the button, the time indication changes as follows:

TOTAL ⇒ **T. (TOTAL) REM** ⇒ **TIME** ⇒ **REM** ⇒
(back to the beginning)

TOTAL : Elapsed time of the disc

T. REM : Remaining time of the disc

TIME : Elapsed playing time of the current chapter/track

REM : Remaining time of the current chapter/track

To turn off the on-screen bar

Press ON SCREEN.

Notes:

• The time indication in the on-screen bar changes as follows:
EX. :

TOTAL 1:25:58 ⇒ T.REM 0:45:41 ⇒ TIME 0:25:58 ⇒
REM 0:18:14 ⇒ (back to the beginning)

The indication on the display also changes.

• While playing VCD, SVCD, or CD, the indication of the hour digit does not appear.

DVD Player Operations

Locating a Desired Scene from the Disc Menu

Using the disc menu, you can start playing a title, chapter, or track you specify.

If the on-screen bar is shown on the TV, press ON SCREEN repeatedly to go off the on-screen bar.

From the DVD menu

DVD VIDEO generally have their own menus which show the disc contents. These menus contain various items such as titles of movies, names of songs, or artist information, and display them on the TV screen. You can locate a desired scene by using these menus.

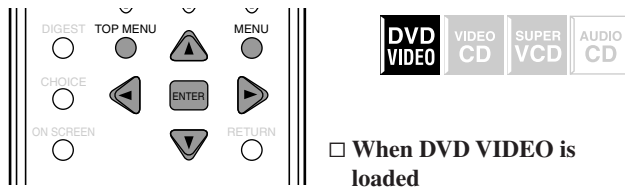

1 Press TOP MENU or MENU.

The DVD menu appears on the TV. (The menu usually appears on the TV automatically after loading DVD VIDEO.)

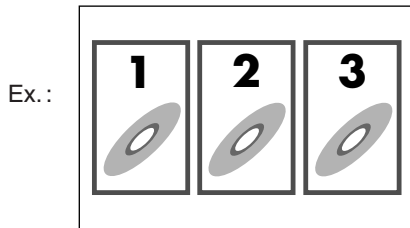

DVD VIDEO normally has a "title" menu when it contains more than one title. In this case, press TOP MENU to show the title menu.

Some DVD VIDEO may also have a different menu which is shown by pressing the MENU button.

See the instructions of each DVD VIDEO for its particular menu.

2 Use cursor ▲/▼/▶/◀ to select a desired item, then press ENTER.

The unit starts playback of the selected item.

- With some discs, you can also select items by entering the corresponding number using number buttons.

From the VCD/SVCD menu with PBC

VCD or SVCD recorded with PBC has its own menus such as a list of the tracks. (After loading such a disc, "PBC" is appears on the display.) You can locate the specific track by using the menu (see also page 30).

- Before using the remote control, press DVD to change the remote control operation mode.

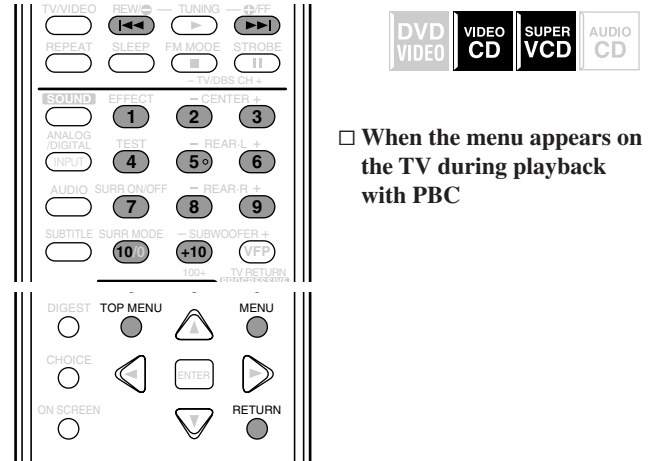

Press number buttons (1-10, +10) to select the number of the desired item.

The unit starts playback from the selected item.

Ex. : To select 3, press 3.

To select 11, press +10, then 1.

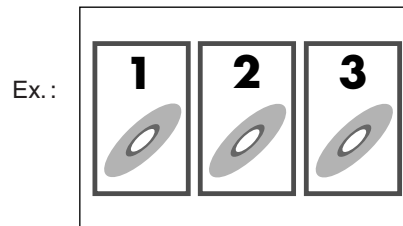

To return to the menu

Press RETURN.

When "NEXT" or "PREVIOUS" is shown on the TV screen:

To go to the next page, press ▶▶.

To return to the previous page, press ◀◀.

To play back PBC-compatible VCD/SVCD without PBC

Start playback by pressing number buttons before starting playback. The elapsed playing time appears on the display instead of "PBC."

To restore PBC

Press TOP MENU or MENU.

"PBC" appears again on the display.

About indication on the display while playing back a VCD/SVCD

While you are playing back a VCD/SVCD recorded with PBC, playback information appears on the display as follows:

Ex. : When VCD is played back using PBC

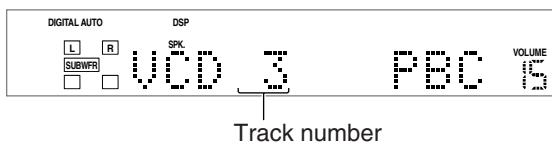

Ex. : When VCD is played back without using PBC

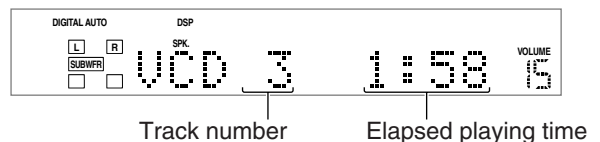

Selecting a View Angle—ANGLE

While playing back DVD VIDEO containing multi-view angles, you can enjoy the same scene at different angles.

The  icon appears at the beginning of playback when the current scene has multi-view angles.

Selecting a view angle



1 Press ANGLE.

The following pop-up window appears on the TV.

Ex. : The first view angle is selected out of 3 view angles recorded.

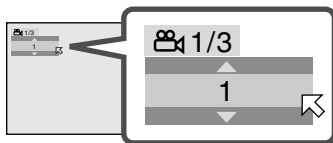

2 Press ANGLE repeatedly to select the desired view angle.

• Each time you press the button, the angle of the scene changes.

Ex.: 1/3 ⇒ 2/3 ⇒ 3/3 ⇒ (back to the beginning)

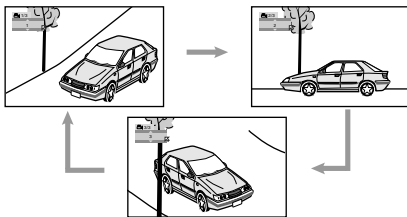

The pop-up window goes off if no operation is done for about 5 seconds.

Using the on-screen bar:

1 Press ON SCREEN repeatedly until the on-screen bar with pull-down menu appears on the TV.

2 Press cursor ► (or ◀) repeatedly to move to in the pull-down menu, then press ENTER.

The following pop-up window appears under the pull-down menu.

Ex. : The first view angle is selected out of 3 view angles recorded.



3 Press cursor ▼ (or ▲) repeatedly to select the desired view angle.

• Each time you press the button, the angle of the scene changes.

4 Press ENTER.

The pop-up window goes off.

To turn off the on-screen bar

Press ON SCREEN.

Showing all view angles on the TV

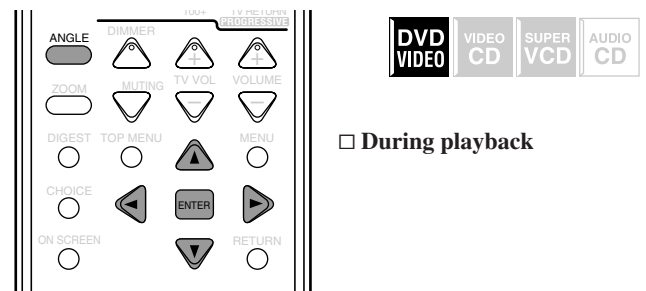

1 Press and hold ANGLE for a few seconds.

Up to 9 pictures of the different camera angles recorded on a disc appear on the TV screen.

Ex. : When 3 view angles are recorded.

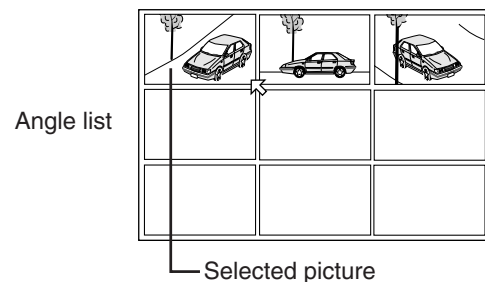

2 Press cursor ▲/▼/►/◀ repeatedly to move to the desired view.

3 Press ENTER.

The angle list goes off, and playback starts at the selected view angle.

Notes:

- While the angle list is shown on the TV, you cannot listen to the sound.
- If "⊘" appears on the TV, the current scene does not contain multi-view angles.

DVD Player Operations

Changing the Languages—SUBTITLE and AUDIO

While playing back DVD VIDEO or SVCD containing subtitles in different languages, you can select the subtitle language to be displayed on the TV.

The  icon appears at the beginning of playback when the current scene has plural subtitles.

When DVD VIDEO contains audio languages (soundtrack), you can select the language (soundtrack) to listen to.

The  icon appears at the beginning of playback when the current scene has plural audio languages.

- You can also select the audio channel(s) of VCD or SVCD.

Selecting the subtitle language

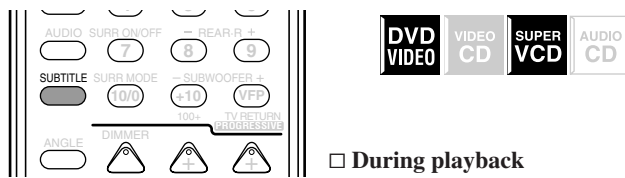

1 Press SUBTITLE.

The following pop-up window appears on the TV.

Ex. : “ENGLISH” is selected among 3 subtitle languages recorded.

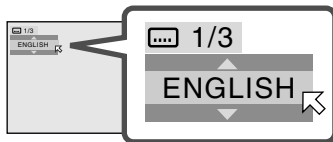

2 Press SUBTITLE repeatedly to select the desired subtitle language.

- Each time you press the button, the subtitle language changes.

The pop-up window goes off if no operation is done for about 5 seconds.

Using the on-screen bar:

1 Press ON SCREEN repeatedly until the on-screen bar with pull-down menu appears on the TV.

2 Press cursor ► (or ◀) repeatedly to move in the pull-down menu, then press ENTER.

The following pop-up window appears under the pull-down menu.

Ex. : “ENGLISH” is selected among 3 subtitle languages recorded.



3 Press cursor ▼ (or ▲) repeatedly to select the desired subtitle language.

- Each time you press the button, the subtitle language changes.

4 Press ENTER.

The pop-up window goes off.

To turn off the on-screen bar

Press ON SCREEN.

Notes:

- For DVD VIDEO: Some subtitle languages are abbreviated in the pop-up window. See “Language code list” on page 50.
- For SVCD: SVCD can contain up to four subtitles. Pressing SUBTITLE changes the subtitles regardless of whether the subtitles are recorded or not. (Subtitles will not change if no subtitle is recorded.)
- If  appears on the TV, the current scene does not contain plural subtitles.

Selecting the audio language

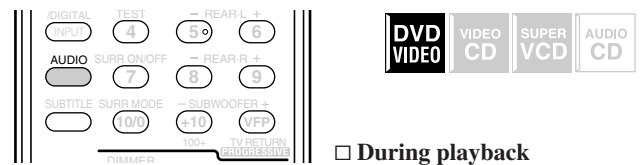

1 Press AUDIO.

The following pop-up window appears on the TV.

Ex. : “ENGLISH” is selected among 3 audio languages recorded.

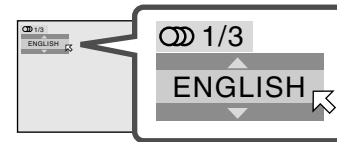

2 Press AUDIO repeatedly to select the desired audio language.

- Each time you press the button, the audio language changes.

The pop-up window goes off if no operation is done for about 5 seconds.

Using the on-screen bar:

1 Press ON SCREEN repeatedly until the on-screen bar with pull-down menu appears on the TV.

2 Press cursor ► (or ◀) repeatedly to move in the pull-down menu, then press ENTER.

The following pop-up window appears under the pull-down menu.

Ex. : “ENGLISH” is selected among 3 audio languages recorded.



3 Press cursor ▼ (or ▲) repeatedly to select the desired audio language.

- Each time you press the button, the audio language changes.

4 Press ENTER.

The pop-up window goes off.

To turn off the on-screen bar

Press ON SCREEN.

Notes:

- Some audio languages are abbreviated in the pop-up window. See "Language code list" on page 50.
- If "⊘" appears on the TV, the current scene does not contain plural audio languages.

■ Selecting the audio channel

When playing back some Karaoke VCDs or SVCDs, you can enjoy karaoke by selecting the audio channel to play.

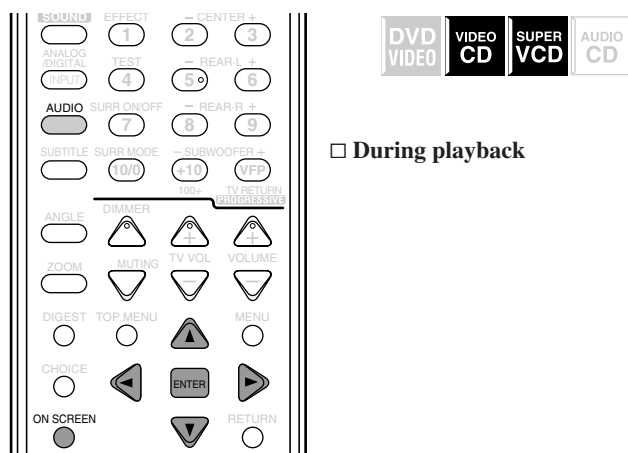

1 Press AUDIO.

The following pop-up window appears on the TV.

Ex. : "ST" (stereo) is selected among 3 audio channels recorded.

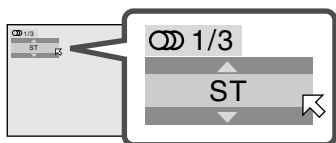

2 Press AUDIO repeatedly to select the desired audio channel.

- Each time you press the button, the audio channel changes.

For VCD :

Ex. :

ST ⇨ L ⇨ R ⇨ (back to the beginning)

ST : To listen to normal stereo playback.

L : To listen to the L (left) audio channel.

R : To listen to the R (right) audio channel.

For SVCD :

Ex. :

ST 1 ⇨ ST 2 ⇨ L 1 ⇨ R 1 ⇨ L 2 ⇨ R 2 ⇨
(back to the beginning)

ST 1/ST 2 : To listen to normal stereo playback of ST 1 or ST 2 channel.

L 1/L 2 : To listen to the L (left) 1 or 2 audio channel.

R 1/R 2 : To listen to the R (right) 1 or 2 audio channel.

The pop-up window goes off if no operation is done for about 5 seconds.

Using the on-screen bar:

1 Press ON SCREEN repeatedly until the on-screen bar with pull-down menu appears on the TV.

2 Press cursor ► (or ◀) repeatedly to move to ⊘ in the pull-down menu, then press ENTER.

The following pop-up window appears under the pull-down menu.

Ex. : "ST" (stereo) is selected among 3 audio channels recorded.

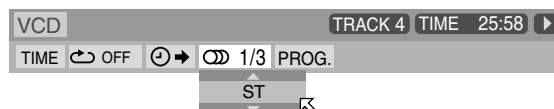

3 Press cursor ▼ (or ▲) repeatedly to select the desired audio channel(s).

- Each time you press the button, the audio channels change.

4 Press ENTER.

The pop-up window goes off.

To turn off the on-screen bar

Press ON SCREEN.

DVD Player Operations

Playing from a Specified Position on a Disc

You can start playing a title, chapter, or track you specify. You can also play a disc from the specified time.

Locating a desired chapter—Chapter Search

When playing back DVD VIDEO, you can search for the chapter number to be played.

- Before using the remote control, press DVD to change the remote control operation mode.

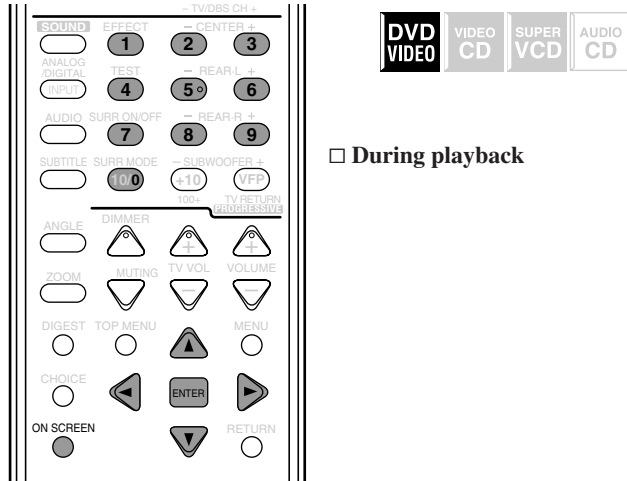

During playback

1 Press ON SCREEN repeatedly until the on-screen bar with pull-down menu appears on the TV.

2 Press cursor \blacktriangleright (or \blacktriangleleft) repeatedly to move \blacktriangleright to CHAP. \blacktriangleright in the pull-down menu, then press ENTER.

The following pop-up window appears under the pull-down menu.

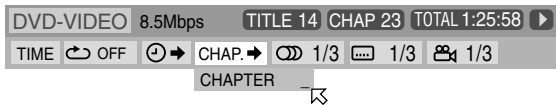

3 Press the number buttons (0–9) to enter the desired chapter number.

Ex. : To select chapter number 8, press 8.
 To select chapter number 10, press 1 then 0.
 To select chapter number 37, press 3 then 7.

- To correct a misentry
 Repeat step 3 until the desired number appears in the pop-up window.

4 Press ENTER.

The unit starts playback from the selected chapter.

To turn off the on-screen bar

Press ON SCREEN.

Notes:

- The 10/0 button works as the 0 button in this function.
- The +10 button is not used in this function.
- You can select up to the 99th chapter.

Locating a desired position—Time Search

You can start playing at your desired position by specifying the elapsed playing time from the beginning of the current title up to “9:59:59” (for DVD VIDEO), or from the beginning of the disc up to “99:59” (for VCD/SVCD/CD).

- Before using the remote control, press DVD to change the remote control operation mode.

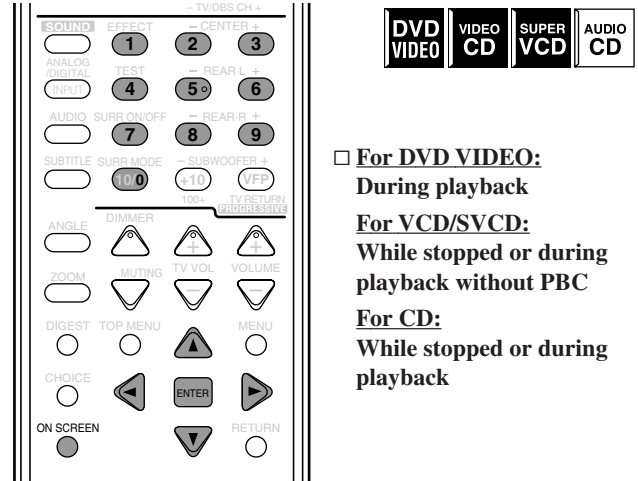

For DVD VIDEO:

During playback

For VCD/SVCD:

While stopped or during playback without PBC

For CD:

While stopped or during playback

1 Press ON SCREEN repeatedly until the on-screen bar with pull-down menu appears on the TV.

2 Press cursor \blacktriangleright (or \blacktriangleleft) repeatedly to move \blacktriangleright to ⌂ in the pull-down menu, then press ENTER.

The following pop-up window appears under the pull-down menu.

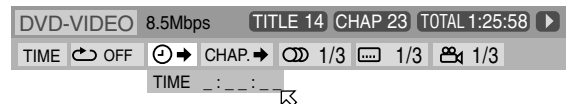

3 Use the number buttons (0–9) to enter the time.

Ex. : To play back from a point of 1 (hours): 32 (minutes): 49 (seconds) from the beginning

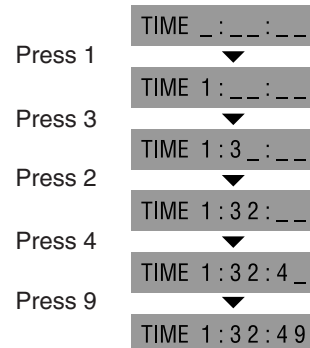

- To correct a misentry

Press cursor \blacktriangleleft repeatedly until the wrong number is erased, then press the number buttons to enter the correct number.

4 Press ENTER.

The unit starts playback from the specified time.

To turn off the on-screen bar
Press ON SCREEN.

Notes:

- The 10/0 button works as the 0 button in this function.
- The +10 button is not used in this function.
- You can specify the time in hours/minutes/seconds for DVD VIDEO, and in minutes/seconds for VCD/SVCD/CD.

Locating a desired scene—DIGEST

The unit can display the opening scenes of each title or chapter on DVD VIDEO or each track of a VCD/SVCD. You can select a desired title, chapter, or track from the opening scenes shown on the TV screen.

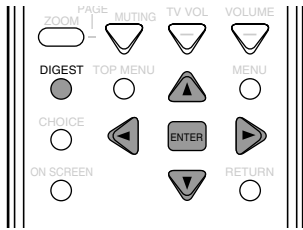

- For DVD VIDEO:**
While stopped or during playback
- For VCD/SVCD:**
While stopped or during playback without PBC

1 Press DIGEST.

Up to 9 opening scenes are displayed.

Selected scene



- **While DVD VIDEO is stopped :**
The opening scenes of each title appear on the TV screen.
- **During DVD VIDEO playback :**
The opening scenes of each chapter in the current title appear on the TV screen.
- **When VCD or SVCD is loaded :**
The opening scenes of each track appear on the TV screen.

2 Press cursor ▲/▼/▶/◀ to move to the desired scene.

- If there are more than 9 scenes, the digest screen will have more than one page.

To show other pages of the digest screen

To display the previous page, select the left top scene, then press cursor ◀.

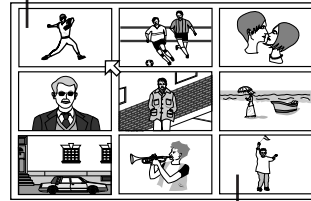

To display the next page, select the right bottom scene, then press cursor ▶.

OR

Press ▶▶ to display the next page.
Press ◀◀ to display the previous page.

3 Press ENTER.

The unit starts playback from the selected scene.

Note:

- For some discs, it may take some time before all the scenes appear on the TV screen.

DVD Player Operations

Special Picture Playback

This unit provides special picture playback functions including frame-by-frame, strobe, slow-motion and zoom.

■ Frame-by-frame playback

- Before using the remote control, press DVD to change the remote control operation mode.

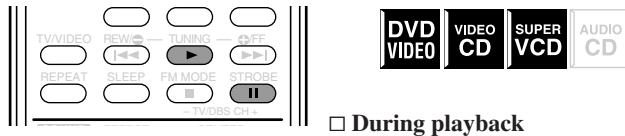

During playback

Press **II** (STROBE) repeatedly.

- Each time you press the button, the still picture advances to the next frame.

To return to normal playback

Press **▶**.

Note:

- You can also perform the above operation using **II** on the front panel.

■ Showing continuous still pictures—STROBE

- Before using the remote control, press DVD to change the remote control operation mode.

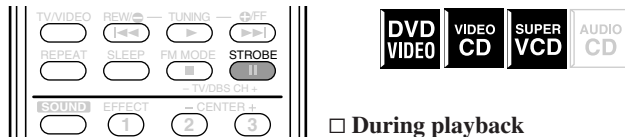

During playback

1 Press **II** (STROBE) at the point you want to view as continuous pictures.

Playback pauses.

2 Press and hold **II** (STROBE) for a few seconds.

The same 9 frames (still pictures) appear on the TV screen. You can advance the frames one by one in the following step.

3 Press **II** (STROBE) once.

The picture in the middle on the top row shows an advanced frame from the one on the left.

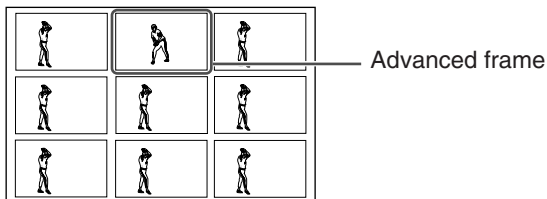

- Pressing the button repeatedly advances the frames one by one.
- Pressing **▶** instead of **II** (STROBE) advances each frame at normal playback speed with a time delay over the all 9 frames. (The sound is muted.)

To return to the normal screen

Press and hold **II** (STROBE) for a few seconds.

Notes:

- If you press and hold **II** (STROBE) for a few seconds during playback, 9 still pictures also appear but they advance in normal playback speed with a time delay. (The sound is muted.)
- You can also perform the above operation using **II** (STROBE) on the front panel.

■ Playing back in slow-motion

- Before using the remote control, press DVD to change the remote control operation mode.

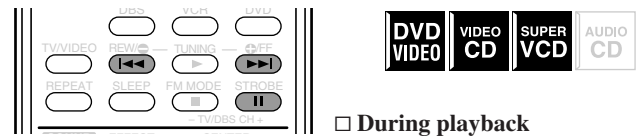

During playback

1 Press **II** (STROBE) at the point where you want to start playback in slow-motion.

Playback pauses.

2 Press and hold **▶▶▶** or **◀◀◀**.

To play back in forward slow-motion, press and hold **▶▶▶**.

To play back in reverse slow-motion (for DVD VIDEO only), press and hold **◀◀◀**.

- Each time you press and hold the button, the playback speed changes as follows:

Forward:



Reverse (for DVD VIDEO only):



To pause slow-motion playback

Press **II** (STROBE).

To return to normal playback

Press **▶**.

Note:

- You cannot listen to the sound during slow-motion playback.

■ Zooming in—ZOOM

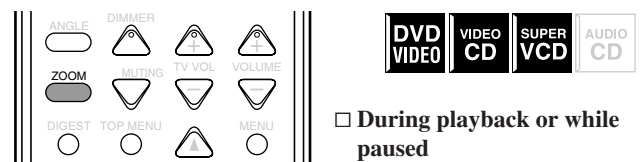

During playback or while paused

Press **ZOOM**.

- Each time you press the button, the magnification changes as follows:

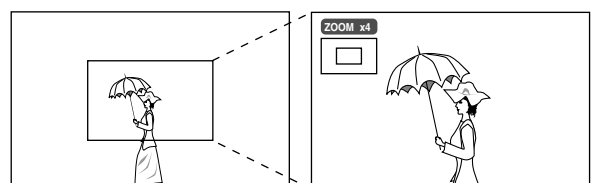
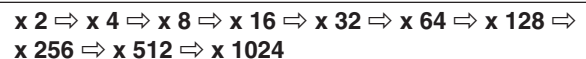

Ex.: When x4 zoom is selected

While being zoomed in, the current magnification and the zoomed-in position of the scene appear at the left top on the screen.

To move the zoomed-in position

Press cursor ▲/▼/▶/◀.

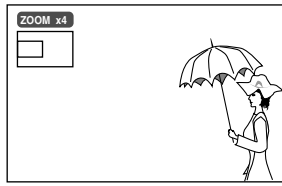

To return to normal playback

Press ENTER.

Note:

- While being zoomed in, the picture may look coarse.

■ Changing the VFP setting—VFP

The VFP (Video Fine Processor) function enables you to adjust the picture based on the picture tone, or personal preference.

- There is a time limit in doing the following steps. If the setting is canceled before you finish, start from step 1 again.
- Before using the remote control, press DVD to change the remote control operation mode.

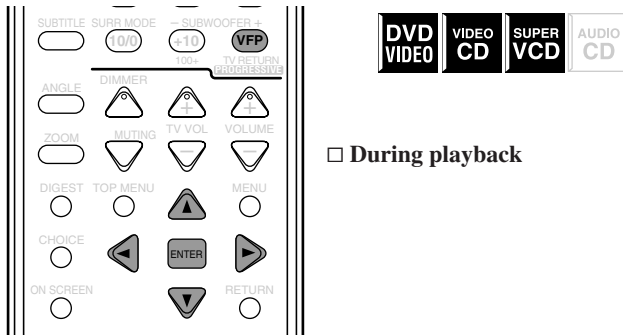

□ During playback

1 Press VFP.

The current VFP setting screen appears on the TV.

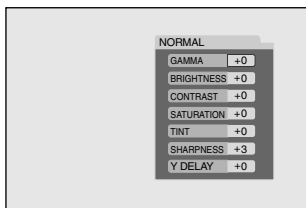

Ex.: When “NORMAL” is selected

2 Press cursor ▶ (or ◀) repeatedly to select the VFP mode.

- Each time you press the button, the VFP mode changes as follows.

NORMAL ⇄ **CINEMA** ⇄ **USER1** ⇄ **USER2** ⇄
(back to the beginning)

- NORMAL** : Normally select this.
- CINEMA** : Suitable for a movie source.
- USER1 and USER2** : You can adjust parameters that affect the appearance of picture and store the settings (see the right).

To turn off the VFP setting screen

Press VFP.

To adjust the appearance of the picture

When selecting “USER1” or “USER2,” you can adjust the appearance of picture

1 Press VFP, then press cursor ▶ (or ◀) repeatedly to select “USER1” or “USER2.”

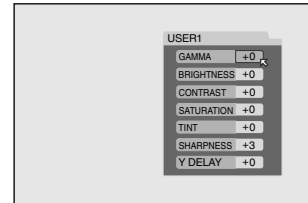

2 Press cursor ▼ (or ▲) repeatedly to select a parameter you want to adjust.

Adjust gradually to show preferable appearance by confirming the picture.

- GAMMA** : Controls the brightness of neutral tints while maintaining the brightness of dark and bright portions (−4 to +4).
- BRIGHTNESS** : Controls the brightness of the screen (−16 to +16).
- CONTRAST** : Controls the contrast of the screen (−16 to +16).
- SATURATION** : Controls the color depth of the screen (−16 to +16).
- TINT** : Controls the tint of the screen (−16 to +16).
- SHARPNESS** : Controls the sharpness of the screen (+0 to +3).
- Y DELAY** : Controls the color gap of the screen (−2 to +2).

3 Press ENTER.

The VFP setting screen disappears, and the following pop-up window appears on the TV.

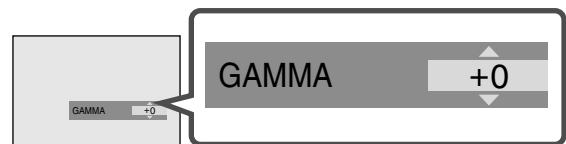

Ex.: When “GAMMA” is selected

4 Press cursor ▼ (or ▲) repeatedly to change the setting, then ENTER.

The current VFP setting screen appears again.

5 Repeat steps 2 to 4 to adjust other parameters.

To turn off the VFP setting screen

Press VFP.

To activate your setting

Press VFP, then press cursor ▶ (or ◀) repeatedly to select “USER1” or “USER2.”

Note:

- The VFP setting screen disappears if no operations are done for more than about 10 seconds.

DVD Player Operations

Program Playback and Random Playback

You can play tracks on VCD, SVCD or CD in the desired order or in the random order.

- You cannot use Resume play for the program or random playback.

■ Playing back in the desired order

You can play up to 99 tracks in the desired order.

- You may program the same tracks more than once.
- Before using the remote control, press DVD to change the remote control operation mode.

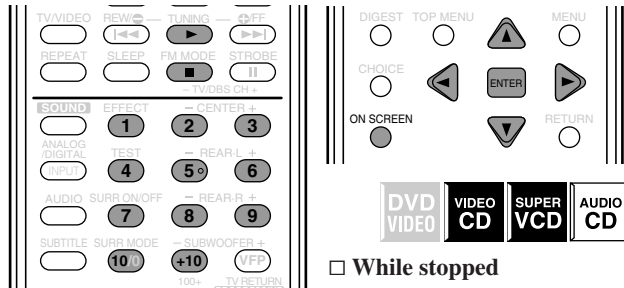

1 Press ON SCREEN repeatedly until the on-screen bar with pull-down menu appears on the TV.

2 Press cursor ► (or ◀) repeatedly to move **PROG.** in the on-screen bar, then press ENTER.

The program screen appears on the TV and the PROGRAM indicator lights up on the display.

- 10 steps appear at a time on the program screen.

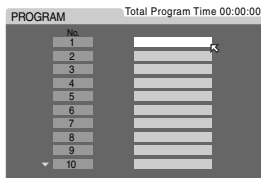

3 Press the number buttons (1–10, +10) to enter a track number you want to program.

Ex. : To select the track number 3, press 3.

To select the track number 14, press +10 then 4.

To select the track number 40, press +10, +10, +10 then 10.

- When you enter a track number that does not exist on the loaded disc, your entry is ignored.
- The total program time is shown at the top of the program screen on the display.

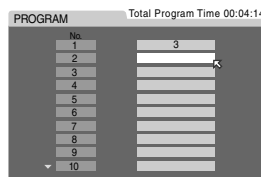

4 Repeat step 3 to program the next steps.

- Each time you enter a track number in the step at the bottom of the program screen, the next steps appear.

To erase a step

Press cursor ▲ (or ▼) to move **PROG.** to the desired step, then press ■.

- To program the next steps again, press cursor ▼ repeatedly to move **PROG.** to the blank step, then repeat step 3.

5 Press ►.

Playback starts in the programmed order.

To stop the program playback

Press ■.

- When VCD or SVCD is played back, the program screen appears again.
- To edit your program, repeat steps 3 and 4.

To cancel the program playback mode

Clear the program you made as follows:

- Press ■ to stop playback.
- Press ON SCREEN to turn on the on-screen bar.
- Press ■.

- You can also clear the program by ejecting the disc or turning off the unit.

To turn off the on-screen bar

Press ON SCREEN.

Notes:

- When all the programmed tracks have been played, the program playback stops.
- If the total program time is over "99:99" on the display, the total program time will not appear ("---:---" will appear).

■ Playing back tracks in random order

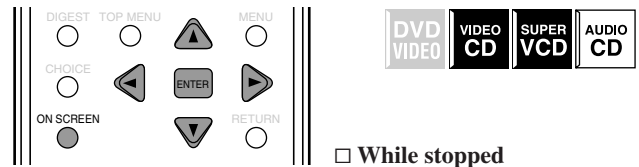

1 Press ON SCREEN repeatedly until the on-screen bar with pull-down menu appears on the TV.

2 Press cursor ► (or ◀) to move **RND.** in the on-screen bar, then press ENTER.

The RANDOM indicator lights up on the display and playback starts in random order.

To stop the random playback

Press ■.

The random playback is canceled.

- When all tracks have been played once, the random playback is also canceled.

Notes:

- The same track will not be played more than once during the random playback.
- During the random playback, you can skip back to the beginning of the current track by pressing ◀◀, but cannot skip back to the tracks that have been played.
- During the random playback, pressing ENTER with **RND.** selected in the on-screen bar cancels the random playback and continues playback in the normal order.

Repeat Playback

You can repeat playback of the current title or chapter (for DVD VIDEO) or track (for VCD/SVCD/CD).

You can also repeat playback of a desired portion.

Repeating a current title, chapter, or all tracks

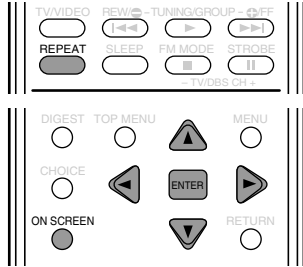

- For DVD VIDEO/CD:**
During playback or while stopped
- For VCD/SVCD:**
During playback or while stopped without PBC

1 Press ON SCREEN repeatedly until the on-screen bar with pull-down menu appears on the TV.

2 Press cursor ► (or ◀) repeatedly to move to in the on-screen bar, then press ENTER.

The following pop-up window appears under the on-screen bar.



3 Press cursor ▼ (or ▲) repeatedly to select the repeat mode, then press ENTER.

- Each time you press cursor ▼ (or ▲), the repeat mode changes as follows:

For DVD VIDEO:

CHAPTER ⇄ TITLE ⇄ A-B ⇄ OFF ⇄
(back to the beginning)

For VCD/SVCD/CD :

TRACK ⇄ ALL ⇄ A-B ⇄ OFF ⇄
(back to the beginning)

- CHAPTER** : Repeats the current chapter (the REPEAT 1 indicator lights up on the display)
- TRACK** : Repeats the current track (the REPEAT 1 indicator lights up on the display)
- TITLE** : Repeats the current title (the REPEAT indicator lights up on the display)
- ALL** : Repeats all the tracks on the disc or of the program (the REPEAT indicator lights up on the display)
- A-B** : Repeats a desired portion (see the right column)
- OFF** : Select this to cancel the repeat mode

- You can directly change the repeat mode (except A-B) for the current chapter, title, track, or disc by pressing REPEAT on the remote control.

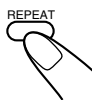

Notes:

- If you select "ALL" during random playback, the all tracks of the disc are played repeatedly in random order.
- "A-B" cannot be selected during the program and random playback or while a disc is not played back.

To turn off the on-screen bar

Press ON SCREEN.

To cancel the repeat playback

Select "OFF" in step **3**, then press ENTER.

Repeating a desired part

You can repeat playback of a desired portion by specifying the beginning (point A) and the ending (point B).

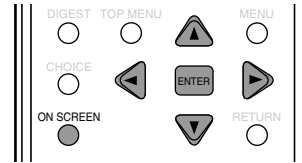

During playback

1 Press ON SCREEN repeatedly until the on-screen bar with pull-down menu appears on the TV.

2 Press cursor ► (or ◀) repeatedly to move to in the on-screen bar, then press ENTER.

The following pop-up window appears under the on-screen bar.



3 Press cursor ▼ (or ▲) repeatedly to select "A-B."

4 Press ENTER at the beginning of the portion you want to repeat (point A).

The following display appears in the on-screen bar.

The REPEAT A indicator also lights up on the display.



5 Press ENTER at the end of the portion you want to repeat (point B).

A-B repeat playback starts. The selected part of the disc (between point A and B) is played repeatedly.

During repeat A-B playback, the REPEAT A-B indicator lights up on the display.



To turn off the on-screen bar

Press ON SCREEN.

To cancel the A-B repeat playback

Select "OFF" in step **3**, then press ENTER.

Note:

- While playing back DVD VIDEO, A-B repeat playback is possible only within the same title.

MP3 Disc Playback

This unit can play back MP3 files on a CD-R or CD-RW. We call such a disc “MP3 disc” in this instruction.

- Before using the remote control, press DVD to change the remote control operation mode for the MP3 disc operations.
- Turn on your TV, and select the correct input mode on the TV.

If “⊘” appears on the TV when you press a button, the disc cannot accept an operation you have tried to do.

What is MP3?

MP3 is an abbreviation of Motion Picture Experts Group 1 (or MPEG-1) Audio Layer 3. MP3 is simply a file format with a data compression. By using MP3 format, one CD-R or CD-RW can contain about 10 times as many songs as a regular CD can.

Disc structure

On an MP3 disc, each song (material) is recorded as a file. Files are usually grouped into a folder. Folders can also include other folders, creating hierarchical folder layers.

This unit simplifies the hierarchical construction of a disc and manages files and folders by “tracks” and “groups.”

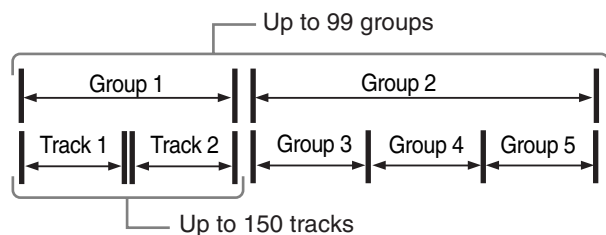

This unit can recognize up to 150 tracks per group, and up to 99 groups per disc (up to 14 850 tracks in total). Since the unit ignores the tracks whose numbers are exceeding 150 and the groups whose numbers are exceeding 99, they cannot be played back.

- If there are any type of files other than MP3 files in a folder, those files are also counted in the total file number.

Notes:

- MP3 discs (either CD-R or CD-RW) require a longer readout time than normal discs. (It depends on the complexity of the folder/file configuration.)
- When making an MP3 disc, select ISO 9660 Level 1 or Level 2 as the disc format.
- This unit supports “multi-session” discs (up to 5 sessions).
- This unit cannot play “packet write” discs.
- This unit can play MP3 files only with the following file extensions: “.MP3,” “.Mp3,” “.mP3,” and “.mp3.”
- ID3* tags cannot be shown on the display.
 - * An MP3 file can contain file information called “ID3 Tag” where its album name, performer, track title, etc. are recorded. There are two versions—ID3v1 (ID3 Tag version 1) and ID3v2 (ID3 Tag version 2).
- It is recommended that you make each MP3 file at sampling rate of 44.1 kHz and at bit rate of 128 kbps. The unit cannot play back the files made at bit rate of under 64 kbps.
- If both MP3 files and JPEG files are recorded on a disc, set the MP3/JPEG setting in the PICTURE menu to “MP3.” (See page 50.)
- Some MP3 discs may not be played back because of their disc characteristics or recording conditions.

Notes:

- The following functions are not available to MP3 disc playback: Program playback, random playback, fast-forward/reverse playback, on-screen bar, and choice menus
- Some tracks on an MP3 disc are skipped and may not be played back normally.

Basic Operations

You can also use the buttons on the front panel if they have the similar names as those on the remote control.

- Before using the remote control, press DVD to change the remote control operation mode.

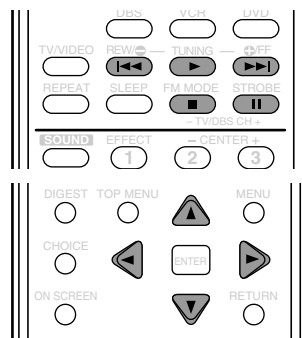

Starting playback

Load an MP3 disc, then press ►.

The unit starts playback. The MP3 control screen appears on the TV (see page 44).

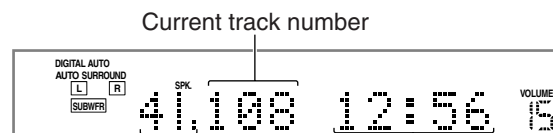

Current track number
Current group number
Elapsed playing time (minutes:seconds) of the current track during playback

When all tracks in a group have been played, the unit plays tracks in the next group.

Stopping playback temporarily

Press II.

To start playback again

Press ►.

Selecting groups or tracks

To skip groups forward

Press cursor ►.

To skip groups backward

Press cursor ◀.

To skip tracks forward

Press ►► or cursor ▼ as many times as required.

To skip to the beginning of the current track

Press ◀◀ once.

To skip tracks backward

Press ◀◀ or cursor ▲ as many times as required.

Stopping playback completely

Press ■.

Operations through the MP3 Control Screen

You can search for and play the desired groups and tracks through the MP3 control screen shown on TV.

MP3 control screen

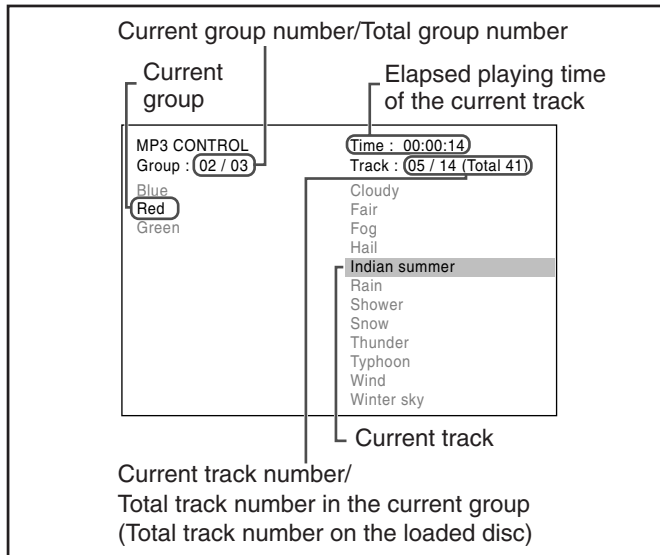

Notes:

- Some group and track names may not be displayed correctly because of their recording conditions.
- The order of groups and tracks on an MP3 disc may be displayed differently from the order displayed on your personal computer.
- Up to 12 groups and tracks are displayed on the TV at a time. Pressing cursor \blacktriangle / \blacktriangledown / \blacktriangleright / \blacktriangleleft repeatedly shows the hidden groups and tracks one by one.

Operations

- Before using the remote control, press DVD to change the remote control operation mode.

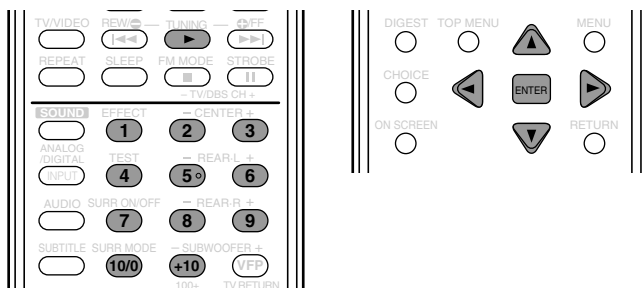

To select or skip groups during playback

To select the next groups (or skip groups forward)

Press cursor \blacktriangleright repeatedly.

To select the previous groups (or skip groups backward)

Press cursor \blacktriangleleft repeatedly.

To select or skip tracks during playback

To select the next tracks (or skip tracks forward)

Press cursor \blacktriangledown repeatedly.

To select the previous tracks (or skip tracks backward)

Press cursor \blacktriangle repeatedly.

To start playback by specifying a track number

Press the number buttons (0–10, +10) to enter the track number.

Ex. : To select the track number 3, press 3.

To select the track number 14, press +10 then 4.

To select the track number 24, press +10, +10, then 4.

To select the track number 110, press +10 ten times, then 10.

The entered number appears in the track number indication, then playback starts from the specified track.

Repeat Playback

You can repeat playback of the current track, group, or all the tracks on the loaded disc.

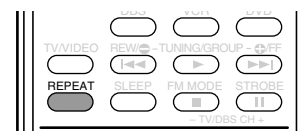

During playback or while stopped

From the remote control ONLY:

Press REPEAT.

The repeat indication appears on the MP3 control screen and the REPEAT indicator lights up on the display.

- Each time you press the button, the repeat mode changes as follows:

REPEAT TRACK \rightleftarrows **REPEAT GROUP** \rightleftarrows **REPEAT ALL**
 \rightleftarrows the indication goes off \rightleftarrows (back to the beginning)

REPEAT TRACK : Repeats the current track

REPEAT GROUP : Repeats the current group

REPEAT ALL : Repeats all the tracks on the disc

To cancel repeat mode

Press REPEAT repeatedly until the repeat indication goes off from the MP3 control screen (the REPEAT indicator also goes off from the display).

JPEG Disc Playback

This unit can play back JPEG files on a CD-R or CD-RW. We call such a disc “JPEG disc” in this instruction.

- Before using the remote control, press DVD to change the remote control operation mode for the JPEG disc operations.
- Turn on your TV, and select the correct input mode on the TV.

If “⊗” appears on the TV when you press a button, the disc cannot accept an operation you have tried to do.

What is JPEG?

A still-picture data compression system proposed by the Joint Photographic Expert Group, which features little distortion in image quality in spite of its high compression ratio.

Disc structure

On a JPEG disc, each still picture (material) is recorded as a file. Files are usually grouped into a folder. Folders can also include other folders, creating hierarchical folder layers.

This unit simplifies the hierarchical construction of a disc and manages folders by “groups.”

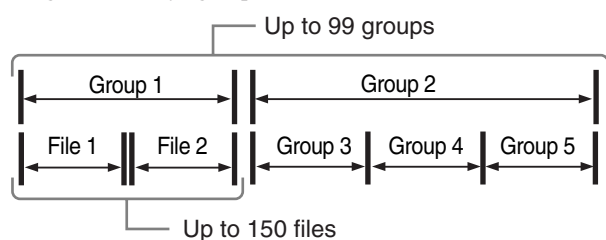

This unit can recognize up to 150 files per group, and up to 99 groups per disc (up to 14 850 files in total). Since the unit ignore the files whose numbers are exceeding 150 and the groups whose numbers are exceeding 99, they cannot be played back.

- If there are any type files other than JPEG files in a folder, those files are also counted in the total file number.

Notes:

- JPEG discs (either CD-R or CD-RW) require a longer readout time than normal discs. (It depends on the complexity of the folder/file configuration.)
- When making a JPEG disc, select ISO 9660 Level 1 or Level 2 as the disc format.
- This unit supports “multi-session” discs (up to 5 sessions).
- This unit cannot play “packet write” discs.
- The unit can play JPEG files only with the following file extensions: “.jpg,” “.jpeg,” “.JPG,” “.JPEG” and any uppercase and lowercase combinations (such as “.Jpg”).
- It is recommended you to record a file at 640 x 480 resolution. (If a file has been recorded at a resolution of more than 640 x 480, it will take a longer time to be shown.)
- If both JPEG files and MP3 files are recorded on a disc, set the MP3/JPEG setting in the PICTURE menu to “JPEG.” (See page 50.)
- This system can play only baseline JPEG files*. Progressive JPEG files* or lossless JPEG files* cannot be played.
 - * – Baseline JPEG format: Used for digital cameras, web, etc.
 - Progressive JPEG format: Used for web.
 - Lossless JPEG format: An old type and rarely used now.
- Some JPEG discs may not be played back because of their disc characteristics or recording conditions.

Slide-show Playback

You can play back the still pictures one after another automatically—slide-show playback.

You can also use the buttons on the front panel if they have the similar names as those on the remote control.

- Before using the remote control, press DVD to change the remote control operation mode.

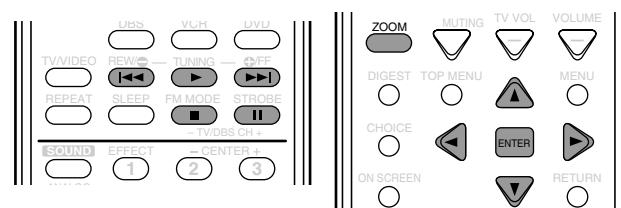

Starting slide-show playback

Load a JPEG disc, then press ►.

The slide-show playback starts. Each file (still picture) is shown on the TV for about 3 seconds, then changed to the next file one after another.

When all files in a group have been played back, the unit plays back files in the next group.

Stopping slide-show playback temporarily

Press ■.

To start slide-show playback again

Press ►.

Zooming in on the still picture

This does not take effect while slide-show is played back, Press ZOOM.

To move the zoomed-in position

Press cursor ▲/▼/►/◄.

To return to normal playback

Press ENTER.

See also pages 39 and 40.

Selecting files or groups

To skip pictures (files) forward

Press ►► or cursor ▼ as many times as required.

To skip pictures (files) backward

Press ◄◄ or cursor ▲ as many times as required.

Stopping slide-show playback completely

Press ■.

The JPEG control display appears on the TV screen.

- For how to operate through the JPEG control screen, see “Operations through the JPEG Control Screen” on page 46.

Notes:

- The following functions are not available to JPEG disc playback: program playback, random playback, repeat playback, fast-forward/reverse playback, on-screen bar, and choice menus.
- If a black screen continuously appears in the slide-show playback: The file currently played may be non-baseline JPEG file. In this case, select a playable file (a baseline JPEG file) again (e.g., pressing ■ or MENU to open the JPEG control display, etc.). Note that it may take a long time to select another file.
- Some files on a JPEG disc may be distorted during playback.

Operations through the JPEG Control Screen

You can search for and show the desired groups and files through the JPEG control screen.

JPEG control screen

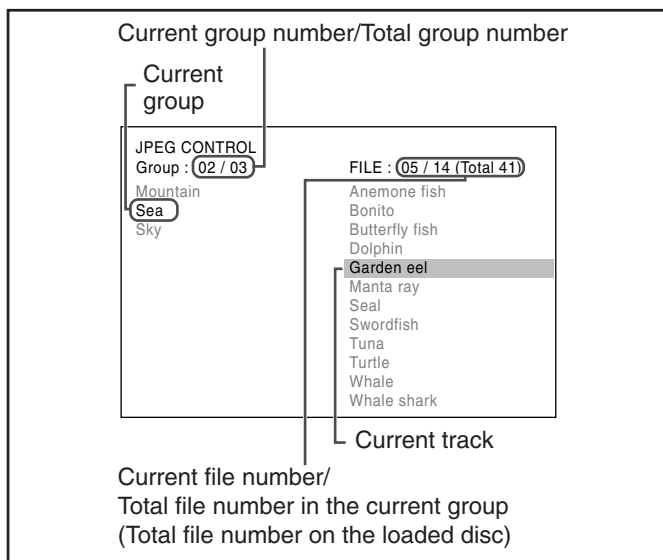

Notes:

- You can check the group number and the file number on the display window.
- Some group and file names may not be displayed correctly because of the recording condition.
- The order of groups and files on a JPEG disc may be displayed differently from the order displayed on your personal computer.

Operations

- Before using the remote control, press DVD to change the remote control operation mode.

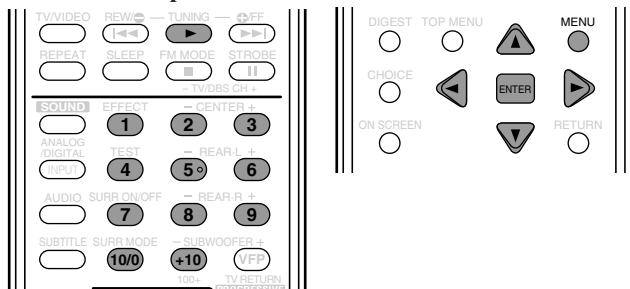

To select or skip groups during the slide-show playback

To select the next groups (or skip groups forward)

Press cursor ► repeatedly.

To select the previous groups (or skip groups backward)

Press cursor ◀ repeatedly.

To select or skip files during the slide-show playback

To select the next files (or skip files forward)

Press cursor ▼ repeatedly.

To select the previous files (or skip files backward)

Press cursor ▲ repeatedly.

Note:

- Up to 12 groups and files are displayed on the TV at a time. Pressing cursor ▲/▼/►/◀ repeatedly shows the hidden groups and files one by one.

To show the selected file only

Press ENTER.

- When the still picture has been shown on the TV screen thoroughly, you can zoom in or out the still picture (see pages 39 and 40).
- If you press ►, the slide-show playback starts from the selected file.

To start the slide-show playback by specifying a file number

Press the number buttons (0–10, +10) to enter the file number.

Ex. : To select the file number 3, press 3.

To select the file number 14, press +10 then 4.

To select the file number 24, press +10, +10, then 4.

To select the file number 110, press +10 ten times, then 10.

The selected file number appears in the file number indication, then the slide-show playback starts from the file you have specified.

To return to the JPEG control screen

Press MENU or ■.

Repeat Playback

You can repeat playback of the current group or all the files on the loaded disc.

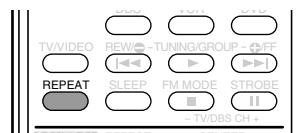

□ During playback or while stopped

From the remote control ONLY:

Press REPEAT.

The repeat indication appears on the JPEG control screen and the REPEAT indicator lights up on the display.

- Each time you press the button, the repeat mode changes as follows:

REPEAT GROUP ⇌ REPEAT ALL ⇌ the indication goes off ⇌ (back to the beginning)

REPEAT GROUP : Repeats the current group

REPEAT ALL : Repeats all the files on the disc

To cancel repeat mode

Press REPEAT repeatedly until the repeat indication goes off from the JPEG control screen (the REPEAT indicator also goes off from the display).

Choice Menu Operations

You can adjust the initial settings through the choice menu on the TV.

Before operating the choice menu, select the source you want to adjust by pressing source selecting button.

- When selecting FM or AM as the source, you cannot use the choice menu.
- When selecting the source other than DVD, FM, and AM, you can use the AUDIO and SPK. SETTING menus. The audio adjustments are memorized for each source.

Notes:

- You need to turn on your TV and select the correct input mode on the TV.
- You can only use the remote control for the choice menu operations.
- You can change the language used in the choice menu. See page 49.
- You cannot show the choice menu when an MP3 disc or a JPEG disc is loaded.

Operation Buttons

To do the operations in this choice menu, use the buttons on the remote control.

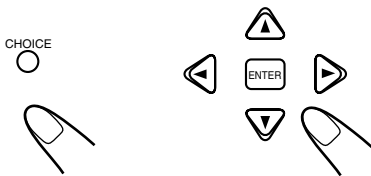

From the remote control ONLY

| Button | To do |
|--------|--|
| CHOICE | display the choice menu on the TV. Each time you press the button, the choice menu is turned on and off alternately. |
| ▲/▼ | select an item. |
| ▶/◀ | adjust the selected item on the choice menu. |
| ENTER | move to the submenu of the selected item or decide the setting. |

Configuration of Choice Menu

The choice menu has the following menus:

LANGUAGE menu (see page 49)

You can select the initial language for the disc menu, audio, and subtitle. You can also select the language used on the TV screen while operating this unit.

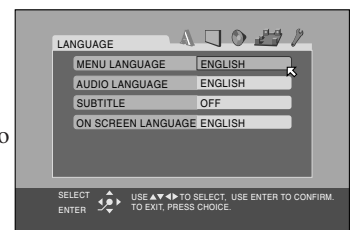

PICTURE menu (see page 49)

You can select the desired options concerning a picture or monitor screen.

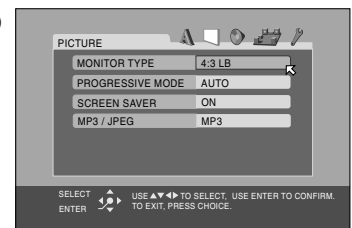

AUDIO menu (see page 50)

You can adjust the sound settings of this unit through this menu.

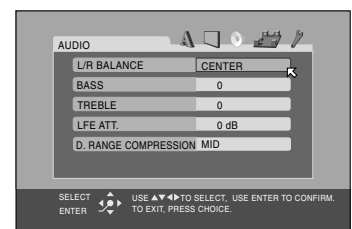

SPK. SETTING menu (see page 51)

You can adjust the speaker settings. You can also adjust the output level of the speakers.

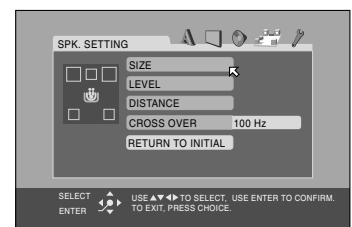

OTHERS menu (see page 52)

You can change the settings for some of the functions. To set Parental Lock, use this menu.

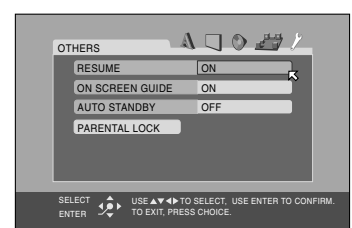

Operating Procedure

Ex. : When setting the progressive mode.

Before operating the choice menu, press DVD to change the source to DVD.

1 Press CHOICE.

The LANGUAGE menu appears on the TV.

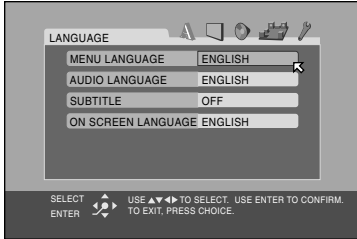

CHOICE

2 Press cursor ► (or ◀) repeatedly to display PICTURE menu.

- Each time you press the button, the menu changes.

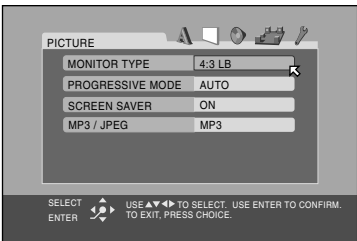

3 Press cursor ▼ (or ▲) repeatedly to move to “PROGRESSIVE MODE.”

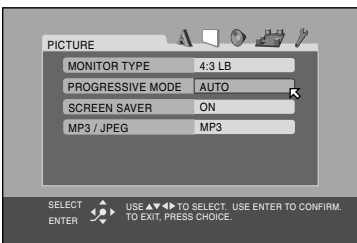

4 Press ENTER.

The pop-up window appears, listing the selectable options.

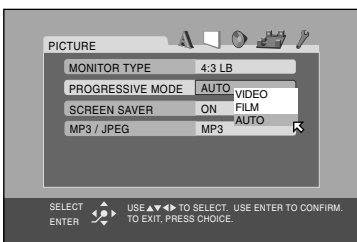

5 Press cursor ▼ (or ▲) repeatedly to select the desired option.

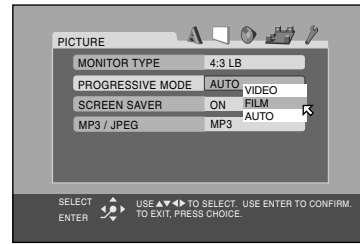

Ex. : When “FILM” is selected.

6 Press ENTER to finish the setting.

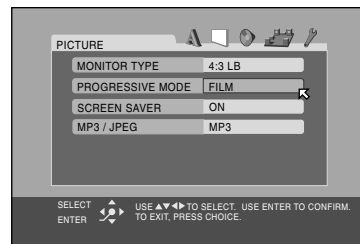

To set other items on the same choice menu

Repeat steps 3 to 6.

To move to another choice menu

Press cursor ► (or ◀) repeatedly to select a choice menu you want to set up.

To return to the normal screen

Press CHOICE.

Note:

- Some items in the choice menu consists of submenus for setting up various options. Pressing ENTER makes the submenus for the selected item appear on the TV. You can set the items using cursor ▲/▼/►/◀ and ENTER (as explained in steps 5 and 6 above).

Choice Menu Operations

■ LANGUAGE menu

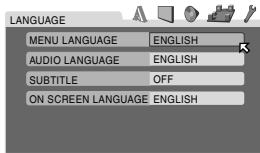

You can select “MENU LANGUAGE,” “AUDIO LANGUAGE,” and “SUBTITLE” only before playback.

● MENU LANGUAGE

Some discs have their own menus in multiple languages.

Select one of the languages or language codes from AA to ZU (see “Language code list” on page 50) as the menu language.

● AUDIO LANGUAGE

Some discs have multiple audio languages.

Select one of the languages or language codes from AA to ZU (see “Language code list” on page 50).

● SUBTITLE

Some discs have multiple subtitle languages.

Select one of the languages or language codes from AA to ZU (see “Language code list” on page 50), or “OFF (no subtitle).”

● ON SCREEN LANGUAGE

Select one of the languages shown on the TV.

Note:

- When the language you have selected for MENU LANGUAGE, AUDIO LANGUAGE, or SUBTITLE is not recorded on a disc, the original language is used as the initial language automatically.

■ PICTURE menu

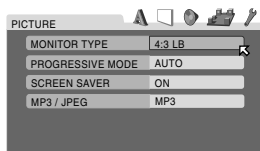

● MONITOR TYPE

You can select the monitor type to match your TV when you play DVD VIDEO recorded in the picture’s height/width ratio of 16:9.

Select one of the following settings:

16:9 NORMAL (Wide television conversion) :

Select this when the aspect ratio of your TV is fixed to 16:9 (wide TV). The unit automatically adjusts the screen width of the output signal correctly when playing back a picture whose aspect ratio is 4:3.

16:9 AUTO (Wide television conversion) :

Select this when the aspect ratio of your TV is 16:9 (wide TV).

4:3 LB (Letter Box conversion) :

Select this when the aspect ratio of your TV is 4:3 (conventional TV). While viewing a wide screen picture, the black bars appear on the top and the bottom of the screen.

4:3 PS (Pan Scan conversion) :

Select this when the aspect ratio of your TV is 4:3 (conventional TV). While viewing a wide screen picture, the black bars do not appear; however, the left and right edges of the pictures will not be shown on the screen.

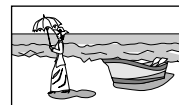

Ex.: 16:9

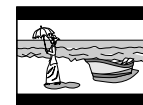

Ex.: 4:3 LB

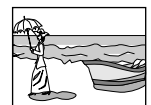

Ex.: 4:3 PS

- Even if “4:3 PS” is selected, the screen size may become “4:3 LB” with some DVD VIDEO. This depends on how they are recorded.
- When you select “16:9 NORMAL” for a picture whose aspect ratio is 4:3, the picture slightly changes due to the process for converting the picture width.

● PROGRESSIVE MODE

You can select the progressive mode according to the picture type (film or video source). This takes effect only when “PROGRESSIVE” is selected as the scanning mode. Normally, set to “AUTO.”

Select one of the following settings:

VIDEO : Suitable for playing back a video source disc.

FILM : Suitable for playing back a film or progressive source disc.

AUTO : Used to play a disc containing both video and film source materials. This unit recognizes the picture type (film or video source) of the current disc according to the disc information.

- If the playback picture is unclear or noisy, or the oblique lines of the picture are rough, try to change to other modes.

● SCREEN SAVER

You can activate or deactivate the screen saver function.

Select one of the following settings:

ON : The picture on the TV becomes dark when no operation is done for 5 minutes.

OFF : The screen saver function does not work.

● **MP3/JPEG**

If both MP3 files and JPEG files are recorded on a disc, you can select which files to play.

Select one of the following settings:

-
- MP3** : Select this for playing MP3 files.
-
- JPEG** : Select this for playing JPEG files.
-

■ **AUDIO menu**

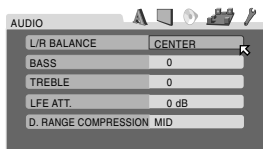

You can also adjust the following items using the front panel or remote control (see pages 19 to 24).

● **L/R BALANCE**

Adjust the output balance between the left front speaker and right front speaker within the range of “R-21” to “CENTER” or “CENTER” to “L-21.”

● **BASS**

Adjust the bass tone level from the front speakers within the range of -10 to +10 in 2-step intervals.

● **TREBLE**

Adjust the treble tone level from the front speakers within the range of -10 to +10 in 2-step intervals.

● **LFE ATT.**

The Low Frequency Effect attenuator diminishes the distortion of the bass sound from the subwoofer while playing back a disc with Dolby Digital or DTS Digital Surround.

Select one of the following settings:

-
- 10 dB** : Select this to diminish the distortion of the bass sound from the subwoofer.
-
- 0 dB** : Select this to cancel this function.
-

● **D. RANGE COMPRESSION**

You can enjoy a powerful sound at night even at a low volume level when listening to the sound with Dolby Digital.

Select one of the following settings:

-
- MAX** : Select this when you want to apply the compression effect fully (useful at midnight).
-
- MID** : Select this when you want to reduce the dynamic range a little.
-
- OFF** : Select this when you want to enjoy surround with its full dynamic range (no effect applied).
-

Language code list

| | | | | | | | | | |
|----|-----------------|----|--------------|----|------------------|----|----------------|----|------------|
| AA | Afar | FA | Persian | KM | Cambodian | OM | (Afan) Oromo | SU | Sundanese |
| AB | Abkhazian | FI | Finnish | KN | Kannada | OR | Oriya | SV | Swedish |
| AF | Afrikaans | FJ | Fiji | KO | Korean (KOR) | PA | Panjabi | SW | Swahili |
| AM | Ameharic | FO | Faroese | KS | Kashmiri | PL | Polish | TA | Tamil |
| AR | Arabic | FY | Frisian | KU | Kurdish | PS | Pashto, Pushto | TE | Telugu |
| AS | Assamese | GA | Irish | KY | Kirghiz | PT | Portuguese | TG | Tajik |
| AY | Aymara | GD | Scots Gaelic | LA | Latin | QU | Quechua | TH | Thai |
| AZ | Azerbaijani | GL | Galician | LN | Lingala | RM | Rhaeto-Romance | TI | Tigrinya |
| BA | Bashkir | GN | Guarani | LO | Laothian | RN | Kirundi | TK | Turkmen |
| BE | Byelorussian | GU | Gujarati | LT | Lithuanian | RO | Rumanian | TL | Tagalog |
| BG | Bulgarian | HA | Hausa | LV | Latvian, Lettish | RU | Russian | TN | Setswana |
| BH | Bihari | HI | Hindi | MG | Malagasy | RW | Kinyarwanda | TO | Tonga |
| BI | Bislama | HR | Croatian | MI | Maori | SA | Sanskrit | TR | Turkish |
| BN | Bengali, Bangla | HU | Hungarian | MK | Macedonian | SD | Sindhi | TS | Tsonga |
| BO | Tibetan | HY | Armenian | ML | Malayalam | SG | Sangho | TT | Tatar |
| BR | Breton | IA | Interlingua | MN | Mongolian | SH | Serbo-Croatian | TW | Twi |
| CA | Catalan | IE | Interlingue | MO | Moldavian | SI | Singhalese | UK | Ukrainian |
| CO | Corsican | IK | Inupiak | MR | Marathi | SK | Slovak | UR | Urdu |
| CS | Czech | IN | Indonesian | MS | Malay (MAY) | SL | Slovenian | UZ | Uzbek |
| CY | Welsh | IS | Icelandic | MT | Maltese | SM | Samoan | VI | Vietnamese |
| DA | Danish | IW | Hebrew | MY | Burmese | SN | Shona | VO | Volapuk |
| DZ | Bhutani | JI | Yiddish | NA | Nauru | SO | Somali | WO | Wolof |
| EL | Greek | JW | Javanese | NE | Nepali | SQ | Albanian | XH | Xhosa |
| EO | Esperanto | KA | Georgian | NL | Dutch | SR | Serbian | YO | Yoruba |
| ET | Estonian | KK | Kazakh | NO | Norwegian | SS | Siswati | ZU | Zulu |
| EU | Basque | KL | Greenlandic | OC | Occitan | ST | Sesotho | | |

Choice Menu Operations

■ SPK. SETTING menu



● SIZE

Select this to enter the SIZE submenu.



FRONT SPEAKER, CENTER SPEAKER, and REAR SPEAKER

Select one of the following settings for each speaker:

LARGE (LRG) : Select this when the speaker size is relatively large.

SMALL (SML) : Select this when the speaker size is relatively small.

NONE (NO) : Select this when you have not connected a speaker. (Not selectable for the front speakers)

SUBWOOFER

Select one of the following settings:

USE (YES) : Select this when a subwoofer is connected.

NONE (NO) : Select this when no subwoofer is used.

RETURN

Select this to return to SPK. SETTING menu.

Notes:

- Keep the following comment in mind as reference when adjusting speaker settings.
 - If the size of the cone speaker unit built in your speaker is greater than 12 cm (4 3/4 inches), select “LARGE,” and if it is smaller than 12 cm (4 3/4 inches), select “SMALL.”
- If you have selected “SMALL” for the front speakers, you cannot select “LARGE” for the center and rear speakers.
- If you have selected “NONE” for subwoofer, you cannot select “SMALL” for the front speakers.
- You can take advantage of the speaker diagrams on the left part of the SPK. SETTING menu to set the speaker.
 - The speaker diagram for the selected speaker is highlighted.
 - The size of the speaker diagram is changed according to your setting.

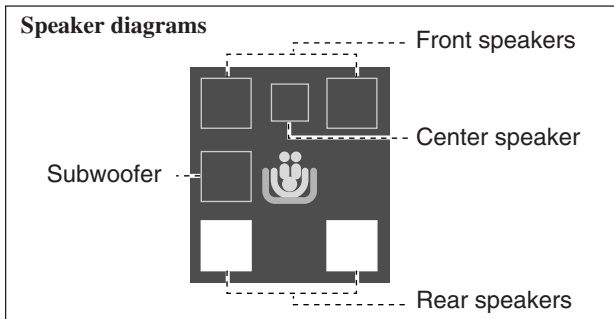

● LEVEL

Select this to enter the LEVEL submenu.



CENTER SPEAKER, LEFT REAR SPEAKER, RIGHT REAR SPEAKER, and SUB WOOFER

Adjust the speaker output level within the range of –10 dB to +10 dB for each speaker.

TEST TONE

Select this to start or stop test tone.

RETURN

Select this to return to SPK. SETTING menu.

Notes:

- When “NONE” is selected for the center speaker, rear speakers and/or subwoofer, “–” appears instead of the current setting. In this case, you cannot adjust the output level of those speakers.
- You can adjust the output level for center speaker and/or speakers only when one of proper surround modes are activated (see page 27).
- When “NONE” is selected for the center and/or rear speakers, the test tone does not come out of those speakers.

● DISTANCE

Select this to enter the DISTANCE submenu.

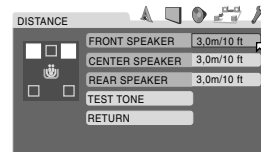

FRONT SPEAKER, CENTER SPEAKER, and REAR SPEAKER

For each speaker, set the distance from the listening point within the range of 1 ft (0.3 m) to 30 ft (9.0 m), in 1 ft (0.3 m) interval.

TEST TONE

Select this to start or stop test tone.

RETURN

Select this to return to SPK. SETTING menu.

Notes:

- When “NONE” is selected for the center speaker and rear speakers on the SIZE menu, “–” appears instead of the current setting. In this case, you cannot adjust the speaker distance of those speakers.
- When “NONE” is selected for the center speaker and rear speakers on the SIZE menu, the test tone does not come out of those speakers.

● CROSS OVER

When you use a small speaker in any position, this unit automatically reallocates the bass sound elements assigned to the small speakers to the large speakers.

To use this function properly, set this crossover frequency level according to the size of the smallest speaker connected.

- If you have selected “LRG (large)” or “LARGE” for all speakers, this function will not take effect.

Select one of the following settings:

200Hz : Select this frequency when the cone speaker unit built in the speaker is less than 2 inches (5 cm).

150Hz : Select this frequency when the cone speaker unit built in the speaker is about 2 ³/₈ inches (6 cm).

120Hz : Select this frequency when the cone speaker unit built in the speaker is about 3 ³/₁₆ inches (8 cm).

100Hz : Select this frequency when the cone speaker unit built in the speaker is about 3 ¹⁵/₁₆ inches (10 cm).

80Hz : Select this frequency when the cone speaker unit built in the speaker is about 4 ³/₄ inches (12 cm).

● RETURN TO INITIAL

Select this to reset all speaker settings to the initial settings.

■ OTHERS menu

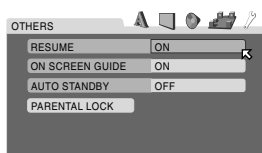

● RESUME

You can activate or deactivate the resume play function of the built-in DVD player.







Select one of the following settings:

ON : Select this to activate this function.

OFF : Select this to deactivate it.

● ON SCREEN GUIDE

You can activate or deactivate the following on-screen guide icons:

- For multi-view angles : 
- For plural subtitles : 
- For plural audio languages : 
- For playback status : , , , , etc.

The on-screen guide icons appear on the TV at the beginning of the playback with this function turned on.

Select one of the following settings:

ON : Select this to activate this function.

OFF : Select this to deactivate it.

- Subtitles (see page 35) and the information for zooming in (see page 39) appear on the display though this setting is “OFF.”
- When Recording mode (see page 14) is activated, the on-screen guide icons do not appear though the setting is “ON.”

● AUTO STANDBY

When the playback of the disc on the built-in DVD player ends and no operation is done for more than the selected time, the unit is turned off automatically.

- This function takes effect only when DVD is selected as the source.

Select one of the following settings:

60 : Turns off the unit if no operation is done within 60 minutes.

30 : Turns off the unit if no operation is done within 30 minutes.

OFF : Select this to deactivate it.

- If Sleep Timer (see page 12) and Auto Standby are used at a time, one with the early shut-off time will turn off the unit.

● PARENTAL LOCK

You can restrict playback of DVD VIDEO containing violent scenes and those not suitable for your family members.

- You can select “PARENTAL LOCK” only before playback.

Select this to enter the PARENTAL LOCK submenu.
(See pages 53 and 54.)

Choice Menu Operations

Restricting Playback by Parental Lock

You can restrict playback of DVD VIDEO containing violent scenes and those not suitable for your family members. Nobody can play such a disc unless this function is canceled.

- This setting takes effect only for the DVD VIDEO containing the Parental Lock level information—Level 1 (most restrictive) to Level 8 (least restrictive).
- You can set the Parental Lock only while playback is stopped.

■ Setting Parental Lock

1 Press **CHOICE**, then press cursor **▶** (or **◀**) to display the **OTHERS** menu.

2 Press cursor **▼** (or **▲**) repeatedly to move **↖** to “**PARENTAL LOCK**,” then press **ENTER**.

The **PARENTAL LOCK** submenu appears on the TV.

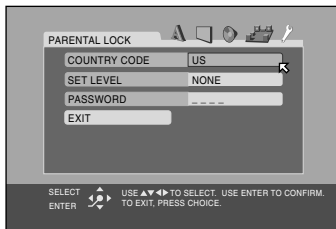

3 Press cursor **▼** (or **▲**) repeatedly to move **↖** to “**COUNTRY CODE**,” then press **ENTER**.

The submenu for setting the country code appears.

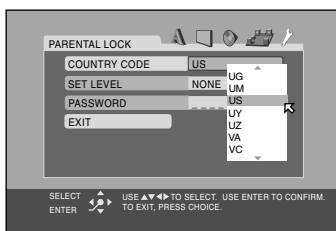

4 Press cursor **▼** (or **▲**) repeatedly to select the country code, then press **ENTER**.

See “Country/Area codes list for Parental Lock” on page 55.

↖ moves to “**SET LEVEL**.”

5 Press **ENTER**.

The pop-up window for setting level appears.

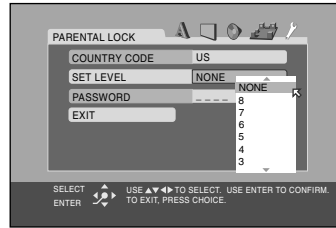

6 Press cursor **▼** (or **▲**) repeatedly to select the level of restriction, then press **ENTER**.

↖ moves to “**PASSWORD**.”

- The smaller the value of level is, the more restrictive the Parental Lock level is.
- Select “**NONE**” to cancel this function.

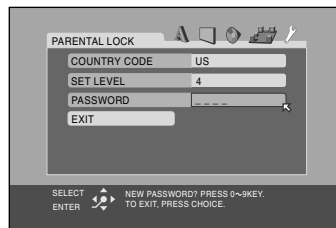

7 Press the number buttons (**0–9**) to enter a four digit number as your password, then press **ENTER**.

↖ moves to “**EXIT**.”

8 Press **ENTER**.

OTHERS menu resumes.

To return to the normal screen

Press **CHOICE**.

Note:

- Remember your password or make a note of it. You need to enter your password to change the setting or release the lock. To change the setting, see page 54.

■ Changing the setting of Parental Lock

1 Press **CHOICE**, then press cursor **▶** (or **◀**) to display the **OTHERS** menu.

2 Press cursor **▼** (or **▲**) repeatedly to move **↔** to “**PARENTAL LOCK**,” then press **ENTER**.

The **PARENTAL LOCK** submenu appears on the TV.

- You can only move **↔** to “**PASSWORD**” or to “**EXIT**” before you enter your password.

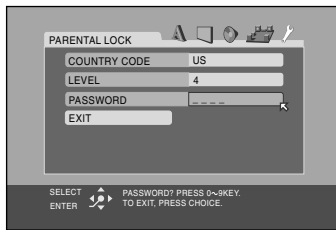

3 Press the number buttons (**0–9**) to enter your password, then press **ENTER**.

- If you enter a wrong password, “**WRONG! RETRY...**” appears on the **PARENTAL LOCK** submenu. You cannot go to next steps before you enter the correct password.

4 Press cursor **▼** (or **▲**) repeatedly to move **↔** to the item you want to change, then press **ENTER**.

5 Press cursor **▼** (or **▲**) repeatedly to change the setting, then press **ENTER**.

6 Press the number buttons (**0–9**) to enter your password, then press **ENTER**.

The new setting is stored.

Notes:

- You cannot set the Parental Lock before you set your password.
- If you go out of the **PARENTAL LOCK** submenu before setting your password in step **6**, the new country code and parental level will not become effective, but the old country code and parental level remain effective.
- When you enter wrong passwords more than three times, **↔** moves to “**EXIT**” automatically and cursor **▼** (or **▲**) does not work. Press **ENTER** to exit from the **PARENTAL LOCK** submenu, then repeat from step **1**.
- If you forget your password, enter “8888.”

■ Releasing Parental Lock temporarily

When you set a strict parental level, some discs may not be played back at all. When you load such a disc and try to play it, the following display appears on the TV. You can release Parental Lock temporarily.

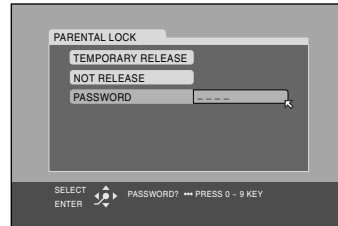

1 Press cursor **▼** (or **▲**) repeatedly to move **↔** to “**TEMPORARY RELEASE**,” then press **ENTER**. **↔** moves to “**PASSWORD**.”

- If you do not want to release Parental Lock temporarily, select “**NOT RELEASE**” by pressing cursor **▼** (or **▲**), then **ENTER**. To eject the disc, press **▲**.

2 Press number buttons (**0–9**) to enter your password.

Playback starts.

- If you enter a wrong password, “**WRONG! RETRY...**” appears on the **PARENTAL LOCK** submenu. You cannot play the disc before you enter the correct password.

Note:

- When you enter wrong passwords more than three times, **↔** moves to “**NOT RELEASE**” automatically and cursor **▼** (or **▲**) does not work. Press **▲** to remove the disc.

Choice Menu Operations

Country/Area codes list for Parental Lock

| | | | | | | | |
|----|--------------------------|----|--|----|----------------------------------|----|--------------------------------------|
| AD | Andorra | ER | Eritrea | LA | Lao People's Democratic Republic | RW | Rwanda |
| AE | United Arab Emirates | ES | Spain | | | SA | Saudi Arabia |
| AF | Afghanistan | ET | Ethiopia | LB | Lebanon | SB | Solomon Islands |
| AG | Antigua and Barbuda | FI | Finland | LC | Saint Lucia | SC | Seychelles |
| AI | Anguilla | FJ | Fiji | LI | Liechtenstein | SD | Sudan |
| AL | Albania | FK | Falkland Islands (Malvinas) | LK | Sri Lanka | SE | Sweden |
| AM | Armenia | FM | Micronesia (Federated States of) | LR | Liberia | SG | Singapore |
| AN | Netherlands Antilles | | | LS | Lesotho | SH | Saint Helena |
| AO | Angola | FO | Faroe Islands | LT | Lithuania | SI | Slovenia |
| AQ | Antarctica | FR | France | LU | Luxembourg | SJ | Svalbard and Jan Mayen |
| AR | Argentina | FX | France, Metropolitan | LV | Latvia | SK | Slovakia |
| AS | American Samoa | GA | Gabon | LY | Libyan Arab Jamahiriya | SL | Sierra Leone |
| AT | Austria | GB | United Kingdom | MA | Morocco | SM | San Marino |
| AU | Australia | GD | Grenada | MC | Monaco | SN | Senegal |
| AW | Aruba | GE | Georgia | MD | Moldova, Republic of | SO | Somalia |
| AZ | Azerbaijan | GF | French Guiana | MG | Madagascar | SR | Suriname |
| BA | Bosnia and Herzegovina | GH | Ghana | MH | Marshall Islands | ST | Sao Tome and Principe |
| BB | Barbados | GI | Gibraltar | ML | Mali | SV | El Salvador |
| BD | Bangladesh | GL | Greenland | MM | Myanmar | SY | Syrian Arab Republic |
| BE | Belgium | GM | Gambia | MN | Mongolia | SZ | Swaziland |
| BF | Burkina Faso | GN | Guinea | MO | Macau | TC | Turks and Caicos Islands |
| BG | Bulgaria | GP | Guadeloupe | MP | Northern Mariana Islands | TD | Chad |
| BH | Bahrain | GQ | Equatorial Guinea | MQ | Martinique | TF | French Southern Territories |
| BI | Burundi | GR | Greece | MR | Mauritania | TG | Togo |
| BJ | Benin | GS | South Georgia and the South Sandwich Islands | MS | Montserrat | TH | Thailand Code Language |
| BM | Bermuda | | | MT | Malta | TJ | Tajikistan |
| BN | Brunei Darussalam | GT | Guatemala | MU | Mauritius | TK | Tokelau |
| BO | Bolivia | GU | Guam | MV | Maldives | TM | Turkmenistan |
| BR | Brazil | GW | Guinea-Bissau | MW | Malawi | TN | Tunisia |
| BS | Bahamas | GY | Guyana | MX | Mexico | TO | Tonga |
| BT | Bhutan | HK | Hong Kong | MY | Malaysia | TP | East Timor |
| BV | Bouvet Island | HM | Heard Island and McDonald Islands | MZ | Mozambique | TR | Turkey |
| BW | Botswana | | | NA | Namibia | TT | Trinidad and Tobago |
| BY | Belarus | HN | Honduras | NC | New Caledonia | TV | Tuvalu |
| BZ | Belize | HR | Croatia | NE | Niger | TW | Taiwan |
| CA | Canada | HT | Haiti | NF | Norfolk Island | TZ | Tanzania, United Republic of |
| CC | Cocos (Keeling) Islands | HU | Hungary | NG | Nigeria | | |
| CF | Central African Republic | ID | Indonesia | NI | Nicaragua | UA | Ukraine |
| CG | Congo | IE | Ireland | NL | Netherlands | UG | Uganda |
| CH | Switzerland | IL | Israel | NO | Norway | UM | United States Minor Outlying Islands |
| CI | Côte d'Ivoire | IN | India | NP | Nepal | | |
| CK | Cook Islands | IO | British Indian Ocean Territory | NR | Nauru | US | United States |
| CL | Chile | | | NU | Niue | UY | Uruguay |
| CM | Cameroon | IQ | Iraq | NZ | New Zealand | UZ | Uzbekistan |
| CN | China | IR | Iran (Islamic Republic of) | OM | Oman | VA | Vatican City State (Holy See) |
| CO | Colombia | IS | Iceland | PA | Panama | | |
| CR | Costa Rica | IT | Italy | PE | Peru | VC | Saint Vincent and the Grenadines |
| CU | Cuba | JM | Jamaica | PF | French Polynesia | | |
| CV | Cape Verde | JO | Jordan | PG | Papua New Guinea | VE | Venezuela |
| CX | Christmas Island | JP | Japan | PH | Philippines | VG | Virgin Islands (British) |
| CY | Cyprus | KE | Kenya | PK | Pakistan | VI | Virgin Islands (U.S.) |
| CZ | Czech Republic | KG | Kyrgyzstan | PL | Poland | VN | Viet Nam |
| DE | Germany | KH | Cambodia | PM | Saint Pierre and Miquelon | VU | Vanuatu |
| DJ | Djibouti | KI | Kiribati | PN | Pitcairn | WF | Wallis and Futuna Islands |
| DK | Denmark | KM | Comoros | PR | Puerto Rico | WS | Samoa |
| DM | Dominica | KN | Saint Kitts and Nevis | PT | Portugal | YE | Yemen |
| DO | Dominican Republic | KP | Korea, Democratic People's Republic of | PW | Palau | YT | Mayotte |
| DZ | Algeria | | | PY | Paraguay | YU | Yugoslavia |
| EC | Ecuador | KR | Korea, Republic of | QA | Qatar | ZA | South Africa |
| EE | Estonia | KW | Kuwait | RE | Réunion | ZM | Zambia |
| EG | Egypt | KY | Cayman Islands | RO | Romania | ZR | Zaire |
| EH | Western Sahara | KZ | Kazakhstan | RU | Russian Federation | ZW | Zimbabwe |

Glossary for DVD Player

Aspect ratio

The ratio of vertical and horizontal sizes of a displayed image. The horizontal vs. vertical ratio of conventional TVs is 4:3, and that of wide-screen TVs is 16:9.

Chapter

The smallest division on DVD VIDEO. It is a division of a title and similar to a track for CD or VCD.

Composite video signal

A video signal comprised of three kinds of signals combined: an image signal made up of luminance and chrominance signals using the frequency multiplication technique; burst signal providing the basis for color reproduction; and synchronization signal.

Component video signal

A video signal system where parts of information necessary for reproducing image signal comprised of the three primary colors of light are transmitted via separate signal lines. Types of signal, such as R/G/B, Y/Pb/Pr, etc., are available.

Disc menu

A screen display prepared for allowing selection of images, sounds, subtitles, multi-angle, etc. recorded on DVD VIDEO.

Interlaced scanning

In the conventional video system, a picture is shown on the display monitor in two halves. The Interlaced scanning system places lines of the second half of the picture in-between lines of the first half of the picture.

JPEG

A still-picture data compression system proposed by the Joint Photographic Expert Group, which features little distortion in image quality in spite of its high compression ratio.

Linear PCM (PCM: Pulse Code Modulation)

A system for converting analog sound signal to digital signal for later processing, with no data compression used in conversion.

Letter box

A method of displaying wide images like movies in on a 4:3 TV screen with no part of the image deleted, by placing black bands on the top and bottom of the screen. This name has derived from the screen form looking literally like a letter box.

MP3

A file format with a sound data compression system. "MP3" is the abbreviation of Motion Picture Experts Group 1 (or MPEG-1) Audio Layer 3. By using MP3 format, one CD-R or CD-RW can contain about 10 times as much data volume as a regular CD can.

Multi-angle

By recording multiple scenes progressing at the same time in a single title, the user can select view angles. This feature is called the multi-angle function.

Multichannel

DVD VIDEO has been designed to have each soundtrack constitute one sound field. Multichannel refers to a structure of sound tracks having three or more channels.

Multilanguage

When a title is created to cope with multiple languages, it is generally called a multilanguage title.

Parental lock

A feature of this system to automatically determine whether or not to reproduce particular DVD VIDEO software by comparing its parental level (a measure of undesirability of scenes, etc. from educational viewpoint) set for the software beforehand with that set on this system by the user; if the software's level is less restrictive than the user-set level, it will be reproduced.

Playback control (PBC)

Refers to the signal recorded on VCD/SVCD for controlling reproduction. By using menu screens recorded on VCD/SVCD that supports PBC, you can enjoy interactive-type software as well as software having a search function.

Progressive scanning

By progressive scanning, all the horizontal lines of a picture are displayed at one time, as a single frame. This system can convert the interlaced video from DVD VIDEO into progressive format for connection to a progressive TV. It dramatically increases the vertical resolution.

Region code

A system for allowing discs to be played back only in the regions designated beforehand. All the countries in the world are divided into six regions and each region is identified by a specified region code (or region number). If the region code of a disc matches that of a player, the player can play back the disc.

Surround

A system for creating three-dimensional sound fields full of realism by arranging multiple speakers around the listener.

Sampling frequency

Frequency of sampling data when analog data is converted to digital data. Sampling frequency numerically represents how many times the original analog signal is sampled per second.

Transfer rate

The rate of transferring digital data. Usually the measure is in bit per second (bps). The DVD system applies a variable transfer rate system for high efficiency.

AV COMPU LINK Remote Control System

The AV COMPU LINK remote control system allows you to operate JVC's video components (TV and VCR) through the unit.

This unit is equipped with the AV COMPU LINK-III, which has added a function to operate JVC's video components through the video components terminals. To use this remote control system, you need to connect the video components you want to operate, following the diagrams below and the procedures on page 58.

- Refer also to the manuals supplied with your video components.

CONNECTIONS 1: AV COMPU LINK Connection

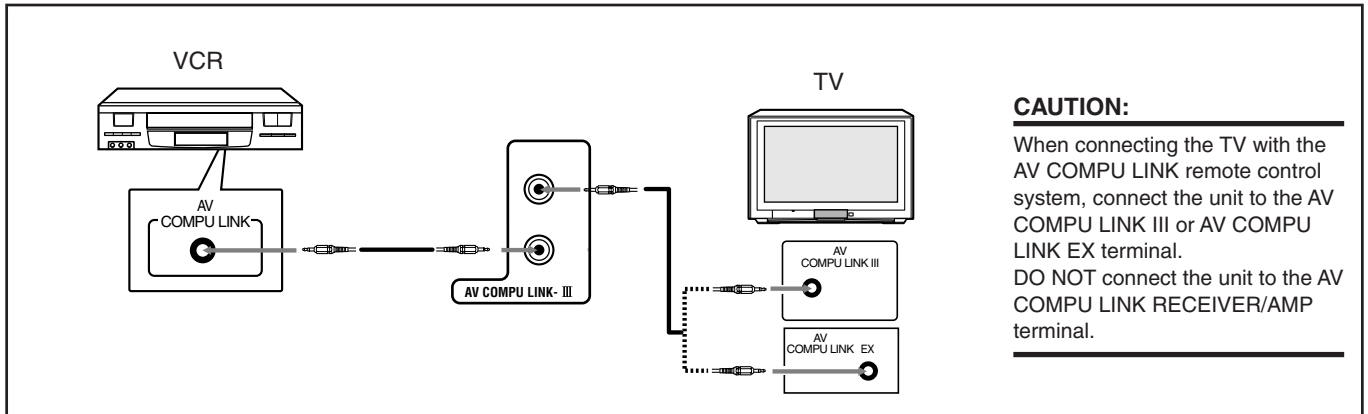

Notes:

- When connecting the unit and a TV with the AV COMPU LINK EX terminal by using a component video cable, you cannot use Automatic Selection of TV's Input Mode (see page 58).
- When connecting the VCR only to this unit, connect it directly to the unit using cables with the monaural mini-plugs.

CONNECTIONS 2: Video Cable Connection

This unit is equipped with three types of the video terminals—composite video, S-video, and component video, and the signals coming into this unit through one type of video terminals can output only through the terminal of the same type. So you need to connect the VCR and TV to this unit using one of the following two ways—CASE 1 or 2:

- **When using the AV COMPULINK remote control system, set the component video input correctly** (see "Video output mode" on page 22); otherwise, the correct input for this unit will not be selected on the TV.

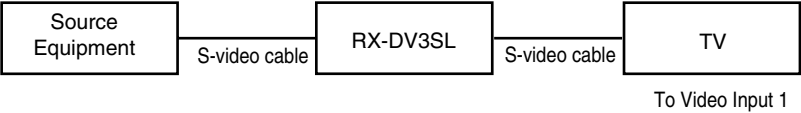
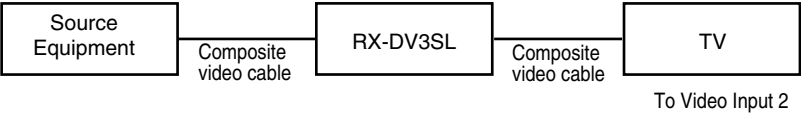
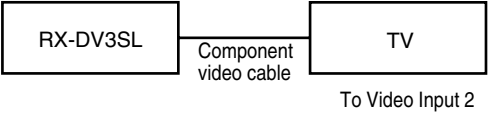
| | |
|--------|--|
| CASE 1 | <p>When connecting the source equipment to the unit through the S-video terminals, connect this unit to the TV's Video Input 1 terminal using S-video cables.</p>  |
| CASE 2 | <p>When connecting the source equipment to the unit through the composite video terminals, connect this unit to the TV's Video Input 2 terminal (composite video input) using composite video cables.</p>  |
| CASE 3 | <p>When setting the video output mode of the built-in DVD player to "component," connect this unit to the TV's Video Input 2 terminals (component video input) using component video cables.</p>  |

1. **If you have already plugged your VCR, TV, and this unit into the AC outlets, unplug their AC power cords first.**
2. **Connect your VCR, TV, and this unit following “CONNECTIONS 1” on the previous page, using the cables with the monaural mini-plugs (not supplied).**
3. **Connect the audio input/output jacks on VCR, TV, and this unit using the audio cords.**
 - See pages 7 to 9.
4. **Connect the video input/output jacks on VCR, TV and this unit following “CONNECTIONS 2” on the previous page, using the composite video cord, with S-video plug or with component video plugs.**
5. **Plug the AC power cords of the components into the AC outlets.**
6. **When turning on the TV for the first time after the AV COMPU LINK connection, turn the TV volume to the minimum using the TV volume control on the TV.**
7. **Turn on other connected components first, then turn on this unit.**
 - When turning on the VCR, use the remote control supplied with this unit—press **⏻/STANDBY/ON VCR**.

The AV COMPU LINK remote control system allows you to use the five basic functions listed below.

Remote Control of the TV and VCR Using This Remote Control

For details, see page 60 .

- Aim the remote control directly at **the remote sensor on each target component.**

One-Touch Video Play

Simply by inserting a video cassette without its safety tab into the VCR, you can enjoy the video playback without setting other switches manually. The unit automatically turns on and changes the source to VCR.

The TV automatically turns on and changes the input mode to the appropriate position so that you can view the playback picture.

When you insert a video cassette with its safety tab, press the play (▶) button on the VCR or on the remote control. You can get the same result.

One-Touch DVD Play

Simply by starting playback on the built-in DVD player, you can enjoy the playback without setting other switches manually.

The TV automatically turns on and changes the input mode to the appropriate position so that you can view the playback picture.

Automatic Selection of TV's Input Mode

- When you select TV as the source to play on the unit, the TV automatically changes the input mode to the TV tuner so that you can watch TV.
- When you select DVD, VCR, or DBS as the source to play on the unit, the TV automatically changes the input mode to the appropriate position so that you can view the playback picture.

Notes:

- *When connecting a TV with the AV COMPU LINK EX terminal to this unit, you cannot use a component video cable (as CASE 3 on the previous page).*
- *When you select TV as the source on the unit, you cannot see the menu on the TV screen since the AV COMPU LINK remote control system automatically changes the TV's input mode to the TV tuner. If you do not mind stopping listening to the TV sounds, you can then show the on-screen menu after changing the TV's input mode to the appropriate position the unit is connected to.*

Automatic Power On/Off

The TV and VCR turn on and off along with the unit.

When you turn on the unit;

- If the previously selected source is VCR, the TV and VCR will turn on automatically.
- If the previously selected source is TV or DVD, only the TV will turn on automatically.

When you turn off the unit, the TV and VCR will turn off.

Note:

- *If you turn off the unit while recording on the VCR, the VCR will not turn off, but continue recording.*

Operating JVC's Audio/Video Components

You can operate JVC's audio and video components with this unit's remote control, since control signals for JVC's components are preset in the remote control.

Operating Audio Components

To operate JVC's audio components using this remote control

- Aim the remote control directly at the remote sensor on the unit.
- To operate a source with the remote control, the source must be selected using the source selecting buttons on the remote control.
- Refer also to the manuals supplied with your components.

Sound control section (Amplifier)

After pressing SOUND, you can perform the following operations:

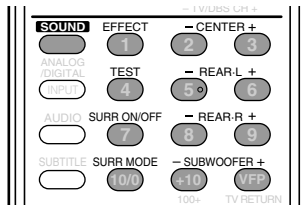

- SURR ON/OFF** : Turns on or off the Surround modes—Dolby Digital, DTS Surround, and Dolby Pro Logic II.
- SURR MODE** : Selects the Surround modes.
- TEST** : Turns on or off the test tone output.
- CENTER + or -** : Adjusts the center speaker channel output level.
- REAR•L + or -** : Adjusts the left rear speaker channel output level.
- REAR•R + or -** : Adjusts the right rear speaker channel output level.
- SUBWOOFER + or -** : Adjusts subwoofer channel output level.
- EFFECT** : Selects the effect level.

Note:

- After adjusting sounds, press the source selecting button to operate your target source by using number buttons; otherwise, number buttons cannot be used for operating your target source.

CD recorder

After pressing CDR, you can perform the following operations on a CD player and a CD recorder:

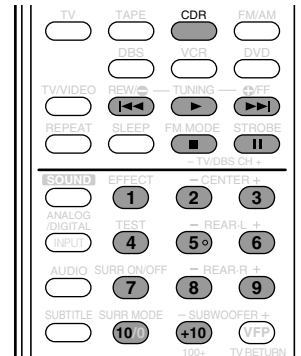

- ▶** : Starts playing.
- ◀◀** : Returns to the beginning of the current (or previous) track.
- ▶▶** : Skips to the beginning of the next track.
- : Stops playing.
- ||** : Pauses playing. To release it, press ▶.
- 1 – 10, +10** : Selects a track number directly.
For track number 5, press 5.
For track number 15, press +10, then 5.
For track number 20, press +10, then 10.
For track number 30, press +10, +10, then 10.

Note:

- When you start recording on the CD recorder, use the buttons on the CD recorder itself or on the remote control supplied with it.

Tuner

You can always perform the following operations:

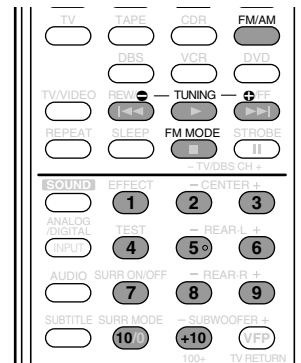

- FM/AM** : Tunes into the last selected FM or AM station.
- Each time you press the button, the band changes between FM and AM alternately.

After pressing FM/AM, you can perform the following operations on a tuner:

- 1 – 10, +10** : Selects a preset channel number directly.
For channel number 5, press 5.
For channel number 15, press +10, then 5.
For channel number 20, press +10, then 10.

TUNING ⊕ or ⊖ : Tunes into stations.

FM MODE : Changes the FM reception mode.

Operating Video Components

To operate JVC's video components using this remote control

- You need to connect JVC's video components through the AV COMPU LINK-III jacks (see page 57) in addition to the audio/video connections (see pages 7 to 10).
- Some JVC's VCRs can accept two types of the control signals—remote codes "A" and "B." Before using this remote control, make sure that the remote control code of the connected VCR is set to code "A."
- To operate the video component(s) using the remote control, aim the remote control directly at the remote sensor on each component, not on this unit.

TV

You can always perform the following operations:

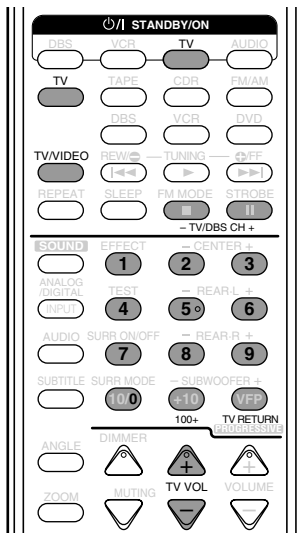

⏻/STANDBY/ON TV : Turns on or off the TV.

- TV VOL + or -** : Adjusts the volume.
TV/VIDEO : Sets the input mode (either TV or VIDEO).

After pressing TV, you can perform the following operations on a TV:

- TV/DBS CH + or -** : Changes the channels.
1 - 9, 0, 100+ : Selects the channels.
 For channel number 5, press 5.
 For channel number 10, press 1, then 0.
 For channel number 23, press 2, then 3.
 For channel number 135, press 100+, 3, then 5.
TV RETURN : Alternates between the previously selected channel and the current channel.

VCR

You can always perform the following operations:

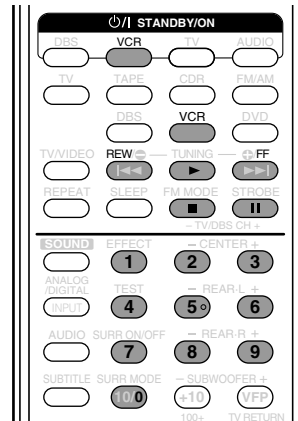

⏻/STANDBY/ON VCR : Turns on or off the VCR.

After pressing VCR, you can perform the following operations on a VCR:

- 1 - 9, 0** : Selects the TV channels on a VCR.
 For channel number 5, press 5.
 For channel number 10, press 1, then 0.
 For channel number 23, press 2, then 3.
▶ : Starts playing.
REW : Rewinds a tape.
FF : Fast-winds a tape.
■ : Stops operations.
|| : Pauses playing. To release it, press ▶.

Operating Other Manufacturers' Equipment

This remote control supplied with the unit can transmit control signals for other manufacturers' TVs, DBS tuners, and VCRs. By changing the transmittable signals from preset ones to other manufacturers', you can operate other manufacturers' components using this remote control.

Changing the Preset Signal Codes

To operate other manufacturers' equipment using this remote control

- Aim the remote control directly at the remote sensor on each equipment.
- To operate a source with the remote control, the source must be selected using source selecting buttons on the remote control.
- Refer also to the manuals supplied with your equipment.

To change the transmittable signals for operating other manufacturers' TV

1. Press and hold

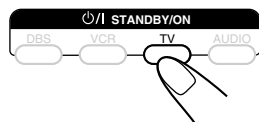
2. Press TV.



3. Enter the manufacturer's code using the number buttons (1-9, 0).
 See the right to find the code.

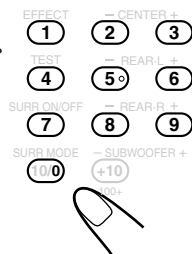

4. Release .

You can perform the following operations on the TV:

-  : Turns on or off the TV.
- TV VOL + or -** : Adjusts the volume.
- TV/VIDEO** : Sets the input mode (either TV or VIDEO).

After pressing TV, you can perform the following operations on a TV:

- TV/DBS CH + or -** : Changes the channels.
- 1 - 9, 0, 100+** : Selects the channels.
 For channel number 5, press 5.
 For channel number 10, press 1, then 0.
 For channel number 23, press 2, then 3.
 For channel number 135, press 100+, 3, then 5.
- TV RETURN will function as the ENTER button if your equipment requires pressing ENTER after selecting a channel number.

Notes:

- Refer also to the manual supplied for your TV.
- All the functions listed above may not be assigned to the buttons for some TVs.
- If you cannot change the channels of some TVs by pressing the number buttons, press TV/DBS CH + or - for changing the channels.

5. Try to operate your TV by pressing STANDBY/ON TV.

When your TV turns on or off, you have entered the correct code.

If there are more than one code listed for your brand of TV, try each one until the correct one is entered.

Manufactures' codes for TV

| Manufacturer | Codes |
|--------------|-------------------------|
| JVC | 00*, 02, 13, 14, 47, 74 |
| Akai | 01, 02 |
| Blaupunkt | 03, 04 |
| Fisher | 01, 05 |
| Grundig | 03, 06, 07 |
| Hitachi | 08 - 10, 49 |
| Iraddio | 02 |
| Itt/Nokia | 11, 12 |
| Loewe | 06, 15, 16 |
| Magnavox | 08, 17, 49 |
| Mets | 50 - 53 |
| Mitsubishi | 08, 18 - 20 |
| Mivar | 21 |
| Nordmende | 22, 23 |
| Okano | 15 |
| Panasonic | 24 - 27, 76 |
| Philips | 15, 17, 28, 75 |
| Quelle | 52 - 67 |
| RCA/PROSC | 08, 24, 29 - 31, 48 |
| SABA | 32, 33, 68 - 70 |
| Samsung | 06, 08, 16, 34, 35, 49 |
| Sanyo | 01, 05 |
| Schneider | 02, 15, 36 |
| Sharp | 37, 38, 77 |
| Sony | 39 |
| Telefunken | 40 - 42, 69 |
| Thomson | 71, 72 |
| Toshiba | 37, 43, 44 |
| Zenith | 45, 46 |

*"00" is the initial JVC code.

Note:

- Manufacturers' codes are subject to change without notice. If they are changed, this remote control cannot operate the equipment.

■ To change the transmittable signals for operating other manufacturers' DBS tuner

1. Press and hold
 ⏻/STANDBY/ON DBS.

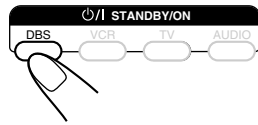

2. Press DBS.

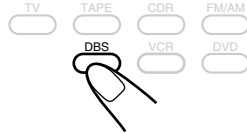

3. Enter manufacturer's code using the number buttons (1-9, 0).

See to the right to find the code.

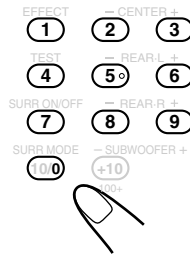

4. Release ⏻/STANDBY/ON DBS.

You can turn on and off the DBS tuner:

⏻/STANDBY/ON DBS : Turns on or off the DBS tuner.

After pressing DBS, you can perform the following operations on a DBS tuner:

TV/DBS CH + or - : Changes the channels.

1 - 9, 0, 100+ : Selects the channels.

- For channel number 5, press 5.
- For channel number 10, press 1, then 0.
- For channel number 23, press 2, then 3.
- For channel number 135, press 100+, 3, then 5.

TV RETURN will function as the ENTER button if your equipment requires pressing ENTER after selecting a channel number.

Note:

- Refer also to the manual supplied for your DBS tuner.

5. Try to operate your DBS tuner by pressing
 ⏻/STANDBY/ON DBS.

When your DBS tuner turns on or off, you have entered the correct code.

If there are more than one code listed for your brand of DBS tuner, try each one until the correct one is entered.

Manufacturers' codes for DBS tuner

| Manufacturer | Codes |
|--------------------|-------------|
| JVC | 56, 57*, 67 |
| Amstrad | 43 - 49 |
| Blaupunkt | 30 |
| Echostar | 50, 51, 67 |
| General Instrument | 29 |
| Goldstar | 31 |
| Grundig | 32, 33 |
| Hamlin/Re | 01 - 05 |
| Hirshmann | 48, 52 - 55 |
| Instrument | 68 |
| Itt/Nokia | 34 |
| Jerrold/G | 06 - 14 |
| Kathrein | 52, 58 - 63 |
| NEC | 35, 36 |
| Oak | 15 - 17 |
| Orbitech | 48 |
| Panasonic | 18 - 20 |
| Philips | 37, 38 |
| Pioneer | 21, 22 |
| RCA | 65 |
| Samsung | 39, 40 |
| Schwaiger | 61, 64 |
| Scientiff | 23 - 25 |
| Siemens | 41, 42 |
| Sony | 66 |
| Technisat | 48 |
| Tocom | 26 |
| Zenith | 27, 28 |

*"57" is the initial JVC code.

Note:

- Manufacturers' codes are subject to change without notice. If they are changed, this remote control cannot operate the equipment.

Operating Other Manufacturers' Equipment

■ To change the transmittable signals for operating other manufacturers' VCR

1. Press and hold /STANDBY/ON VCR.

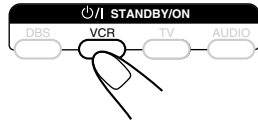

2. Press VCR.

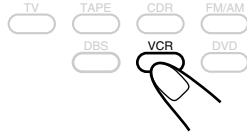

3. Enter the manufacturer's code using number buttons (1-9, 0).

See the right to find the code.

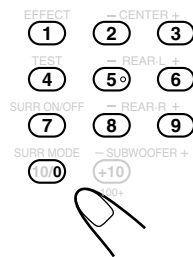

4. Release /STANDBY/ON VCR.

You can turn on and off the VCR:

/STANDBY/ON VCR : Turns on or off the VCR.

After pressing VCR, you can perform the following operations on a VCR:

1 - 9, 0 : Selects the TV channels on a VCR.

For channel number 5, press 5.

For channel number 10, press 1, then 0.

For channel number 23, press 2, then 3.

TV RETURN will function as the ENTER button if your equipment requires pressing ENTER after selecting a channel number.

▶ : Starts playing.

REW : Rewinds a tape.

FF : Fast-winds a tape.

■ : Stops operations.

|| : Pauses playing. To release it, press **▶**.

Note:

- Refer also to the manual supplied for your VCR.

5. Try to operate your VCR by pressing

/STANDBY/ON VCR.

When your VCR turns on or off, you have entered the correct code.

If there are more than one code listed for your brand of VCR, try each one until the correct one is entered.

Manufactures' codes for VCR

| Manufacturer | Codes |
|---------------|-----------------------------|
| JVC | 00*, 26 - 29, 58 |
| Aiwa | 01, 02 |
| Bell & Howell | 03 |
| Blaupunkt | 04, 05 |
| CGM | 06, 07 |
| Emerson | 08, 10 - 12, 64, 65 |
| Fisher | 03, 14 - 17 |
| Funai | 01 |
| GE | 18 - 20 |
| Goldstar | 07 |
| Goodmans | 13, 21 |
| Grundig | 06, 22 |
| Hitachi | 18, 23 - 25, 66 |
| Loewe | 07, 21 |
| Magnavox | 04, 19, 24 |
| Mitsubishi | 30 - 35 |
| NEC | 26, 27 |
| Nokia | 03, 36 |
| Nordmende | 38 |
| Orion | 09 |
| Panasonic | 19, 24, 39, 40 |
| Philips | 04, 19, 21, 24, 41, 42 |
| Phonola | 21 |
| RCA/PROSC | 04, 18, 19, 23, 24, 43 - 45 |
| SABA | 38, 46 |
| Samsung | 45, 47, 59, 61 - 63 |
| Sanyo | 03, 48, 49 |
| Sharp | 37, 50 |
| Siemence | 03, 51 |
| Sony | 52 - 54 |
| Telefunken | 55, 60 |
| Toshiba | 43, 44 |
| Zenith | 56, 57 |

*"00" is the initial JVC code.

Note:

- Manufacturers' codes are subject to change without notice. If they are changed, this remote control cannot operate the equipment.

Maintenance

To get the best performance of the system, keep your discs and mechanism clean.

General Notes

In general, you will have the best performance by keeping your discs and mechanism clean.

- Store discs in their cases, and keep them in cabinets or on shelves.

Handling Discs

- Remove the disc from its case by holding it at the edge while pressing the center hole lightly.
- Do not touch the shiny surface of the disc, or bend the disc.
- Put the disc back in its case after use to prevent warping.



- Be careful not to scratch the surface of the disc when placing it back in its case.
- Avoid exposure to direct sunlight, temperature extremes, and moisture.

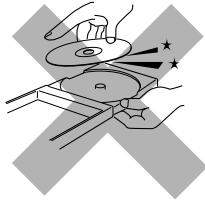

Cleaning Discs

Wipe the disc with a soft cloth in a straight line from center to edge.



DO NOT use any solvent—such as conventional record cleaner, spray, thinner, or benzine—to clean the disc.

Cleaning the Unit

- Stains on the unit
Should be wiped off with a soft cloth. If the unit is heavily stained, wipe it with a cloth soaked in water-diluted neutral detergent and wrung well, then wipe clean with a dry cloth.
- Since the unit may deteriorate in quality, become damaged or get its paint peeled off, be careful about the following.
 - DO NOT wipe it with a hard cloth.
 - DO NOT wipe it strong.
 - DO NOT wipe it with thinner or benzine.
 - DO NOT apply any volatile substances such as insecticides to it.
 - DO NOT allow any rubber or plastic to remain in contact with it for a long time.

Troubleshooting

Use this chart to help you solve daily operational problems. If there is any problem you cannot solve, contact your dealer.

■ General

| PROBLEM | POSSIBLE CAUSE | SOLUTION |
|---|---|--|
| The power does not come on. | The power cord is not plugged in. | Plug the power cord into an AC outlet. |
| No sound from speakers. | Speaker signal cables are not connected. | Check speaker wiring and reconnect if necessary. |
| | The audio cable is not connected properly. | Connect the cord properly (see pages 7 to 10). |
| | An incorrect source is selected. | Select the correct source. |
| | Muting is activated. | Press MUTING to cancel the muting. |
| | An incorrect input mode (analog or digital) is selected. | Select the correct input mode (analog or digital). |
| Sound from one speaker only. | Connections are incorrect. | Check connections. |
| | The balance is set to one extreme. | Adjust the balance properly (see pages 24 or 50). |
| "OVERLOAD" starts flashing on the display. | Speakers are overloaded because of high volume. | <ol style="list-style-type: none"> 1. Press ⏻/STANDBY/ON on the front panel to turn off the unit. 2. Stop the playback source. 3. Turn on the unit again, and adjust the volume. |
| | Speakers are overloaded because of short circuit of speaker terminals. | <p>Press ⏻/STANDBY/ON on the front panel to turn off the unit, then check the speaker wiring.</p> <p>If "OVERLOAD" does not disappear, unplug the AC power cord, then plug it back again.</p> <p>If speaker wiring is not short-circuited, contact your dealer.</p> |
| The STANDBY lamp lights up after turning on the power, but soon the unit turns off (into standby mode). | The unit is overloaded because of a high voltage. | Press ⏻/STANDBY/ON on the front panel to turn off the unit. After unplugging the power cord, consult your dealer. |
| Remote control does not operate as you intend. | The remote control is not ready for your intended operation. | Press SOUND (see page 24) or a source selecting button first, then press the buttons you want to use. |
| Remote control does not work. | It is too far from the unit, or is not facing the unit. | Come closer to the unit. Operate the remote control within 23 ft (7 m) from the unit. |
| | There is an obstruction hiding the remote sensor on the unit. | Remove the obstruction. |
| | The remote control is not aimed at the remote sensor on the unit or components. | Aim the remote control at the remote sensor on each component you want to operate. |
| | The batteries have been inserted into the wrong way round (+/-). | Insert the batteries correctly. |
| | Batteries are weak. | Replace batteries. |
| | The remote control signals are not set correctly. | Enter the correct manufacturers' code (see pages 61 to 63). |

■ For DVD Player

| PROBLEM | POSSIBLE CAUSE | SOLUTION |
|---|---|--|
| No picture is displayed on the TV. | The video cord is not connected correctly. | Connect the cord correctly (see page 8). |
| | TV input selection is incorrect. | Select the correct input on the TV. |
| | The disc is not playable. | Replace the disc (see page 29). |
| No picture is displayed on the TV screen, the picture is blurred, or the picture is divided into two parts. | The scan mode is set to "PROGRESSIVE" though the unit is connected to the TV which does not support the progressive video input, such as a conventional TV. | Change the scan mode to "INTERLACE" (see page 14). |
| A disc cannot be played. | The unit's and disc's Region Code numbers are incompatible. | Replace the disc (see page 29). |
| | Parental Lock is in use. | Enter your password to change the parental level (see pages 53 and 54). |
| A disc cannot be played and "0:00" is displayed on the display window. | The disc is loaded with its label and data sides inverted. | Insert the disc correctly (see page 15). |
| | The unplayable disc is loaded. | Replace the disc (see page 29). |
| | The disc is scratched or dirty. | Replace or clean the disc (see page 63). |
| | A VCR is connected between the unit and the TV. | Connect the unit and TV directly. |
| | With some discs, a picture may be blurred when setting "PROGRESSIVE MODE" to "FILM" or "AUTO." | Set "PROGRESSIVE MODE" to "VIDEO" (see page 49). |
| | "MONITOR TYPE" is not set correctly. | Set the monitor type correctly (see page 49). |
| The picture does not fit the TV screen properly. | The TV is not set correctly. | Set the TV correctly. |
| One-touch DVD playback does not work though you have connected AV COMPU LINK cord correctly. | The video output mode setting is incorrect. | Set the video output mode correctly according to the video connection between your TV and the unit (see page 22). |
| No subtitle appears on the TV screen though you have selected as your initial subtitle language. | | Some discs are programmed to always display no subtitle initially. If this happens, press SUBTITLE on the remote control after starting play (see page 35). |
| Audio language is different from the one you have selected as your initial audio language. | | Some discs are programmed to always use the original language initially. If this happens, press AUDIO on the remote control after starting play (see page 35). |

Troubleshooting

■ For Tuner

| PROBLEM | POSSIBLE CAUSE | SOLUTION |
|---|---|---|
| Hard to listen to broadcast because of noise. | The AM loop antenna is too close to the unit. The supplied FM antenna is not properly extended and positioned. | Change the position and direction of the AM loop antenna. Extend the FM antenna at the best position. |
| Continuous hiss or buzzing during FM reception. | Incoming signal is too weak. The station is too far away. An incorrect antenna is used. | Connect an outdoor FM antenna or contact your dealer. Select a new station. Check with your dealer to be sure you have a correct antenna. |
| Occasional cracking noise during FM reception. | Antennas are not connected properly. Ignition noise from automobiles. | Check connections. Move the antenna farther from automobile traffic. |

■ For MP3

| PROBLEM | POSSIBLE CAUSE | SOLUTION |
|--|--|--|
| A disc cannot be played. | No MP3 files are recorded on the disc. The disc is unplayable (such as CD-ROM). MP3 files do not have the correct file extension—.mp3, .Mp3, .mP3, or .MP3 in their file names. MP3 files are made at bit rate under 64 kbps. | Replace the disc. Add the file extension—.mp3, .Mp3, .mP3, or .MP3—to their file names (see page 43). |
| No MP3 files except JPEG files are played. | MP3 files are not recorded in the format compliant with ISO 9660 Level 1 or 2. The MP3/JPEG setting is set to “JPEG.” | This unit cannot play back such files. Replace the disc. Replace the disc. (Record MP3 files using a compliant application.) When both MP3 files and JPEG files are recorded on a disc, to play MP3 files, set the MP3/JPEG setting to “MP3” (see page 50). |

■ For JPEG

| PROBLEM | POSSIBLE CAUSE | SOLUTION |
|--|--|---|
| A disc cannot be played. | No JPEG files are recorded on the disc. The disc is unplayable (such as CD-ROM). JPEG files do not have the correct file extension in their file names. | Replace the disc. Add the file extension—.jpg, .jpeg, .JPG, .JPEG or any uppercase and lowercase combination (such as “.Jpg”)—to their file names (see page 45). |
| No JPEG files except MP3 files are played. | JPEG files are not made with baseline JPEG format. JPEG files are not recorded in the format compliant with ISO 9660 Level 1 or 2. The MP3/JPEG setting is set to “MP3.” | This unit cannot play back such files. Replace the disc. Replace the disc. (Record JPEG files using a compliant application.) When both MP3 files and JPEG files are recorded on a disc, to play JPEG files, set the MP3/JPEG setting to “JPEG” (see page 50). |

Amplifier

| | |
|--------------|--|
| Output Power | At Stereo operation: Front channels: 100 W per channel, min. RMS, driven into 8 Ω, 40 Hz to 20 kHz with no more than 0.8% total harmonic distortion. |
| | At Surround operation: |
| | Front channels: 100 W per channel, min. RMS, driven into 8 Ω at 1 kHz, with no more than 0.8% total harmonic distortion. |
| | Center channel: 100 W, min. RMS, driven into 8 Ω at 1 kHz, with no more than 0.8% total harmonic distortion. |
| | Rear channels: 100 W per channel, min. RMS, driven into 8 Ω at 1 kHz, with no more than 0.8% total harmonic distortion. |

Audio

| | | |
|--|--|------------------------------------|
| Audio Input Sensitivity/Impedance (1 kHz): | TV, TAPE/CDR, DBS, VCR: | 240 mV/47 kΩ |
| Audio Input (DIGITAL IN)* : | Coaxial: DIGITAL 1 (DBS): | 0.5 V(p-p)/75 Ω |
| | Optical: DIGITAL 2 (TV): | -21 dBm to -15 dBm (660 nm ±30 nm) |
| | * Corresponding to Linear PCM, Dolby Digital, and DTS Digital Surround (with sampling frequency—32 kHz, 44.1 kHz, 48 kHz). | |
| Signal-to-Noise Ratio (*66 IHF/78 IHF): | TV, TAPE/CDR, DBS, VCR: | 87 dB/67 dB |
| Frequency Response (8 Ω): | TV, TAPE/CDR, DBS, VCR: | 20 Hz to 20 kHz (±1 dB) |
| Tone Control: | Bass (100 Hz): | ±10 dB |
| | Treble (10 kHz): | ±10 dB |

Video

| | | |
|--|--------------------------|--|
| Video Input Sensitivity/Impedance (1 kHz): | | |
| Composite video: | DBS IN, VCR IN: | 1 V(p-p)/75 Ω |
| S-VIDEO: | DBS IN, VCR IN: | (Y:luminance): 1 V(p-p)/75 Ω (C:chrominance): 0.286 V(p-p)/75 Ω |
| Video Output Level/Impedance (1 kHz): | | |
| Composite video: | VCR OUT, MONITOR OUT: | 1 V(p-p)/75 Ω |
| S-VIDEO: | VCR OUT, MONITOR OUT: | (Y:luminance): 1 V(p-p)/75 Ω (C:chrominance): 0.286 V(p-p)/75 Ω |
| Component video: | DVD COMPONENT VIDEO OUT: | (Component-Y): 1.0 V(p-p)/75 Ω (Component-PB/PR): 0.7 V(p-p)/75 Ω |
| Color System: | NTSC | |
| Horizontal Resolution: | 500 lines | |
| Signal-to-Noise Ratio (S/N): | 63 dB | |
| Synchronize: | Negative | |

FM tuner (IHF)

| | |
|---------------|-----------------------|
| Tuning Range: | 87.5 MHz to 108.0 MHz |
|---------------|-----------------------|

AM tuner

| | |
|---------------|----------------------|
| Tuning Range: | 530 kHz to 1 710 kHz |
|---------------|----------------------|

General

| | |
|-------------------------|--|
| Power Requirements: | AC 120V [~] , 60 Hz |
| Power Consumption: | 200 W/255 VA (in operation) 2 W (in standby mode) |
| Dimensions (W x H x D): | 435 mm x 100 mm x 403.5 mm (17 ³ / ₁₆ in. x 3 ¹⁵ / ₁₆ in. x 15 ¹⁴ / ₁₆ in.) |
| Mass: | 7.9 kg (17.4 lbs) |

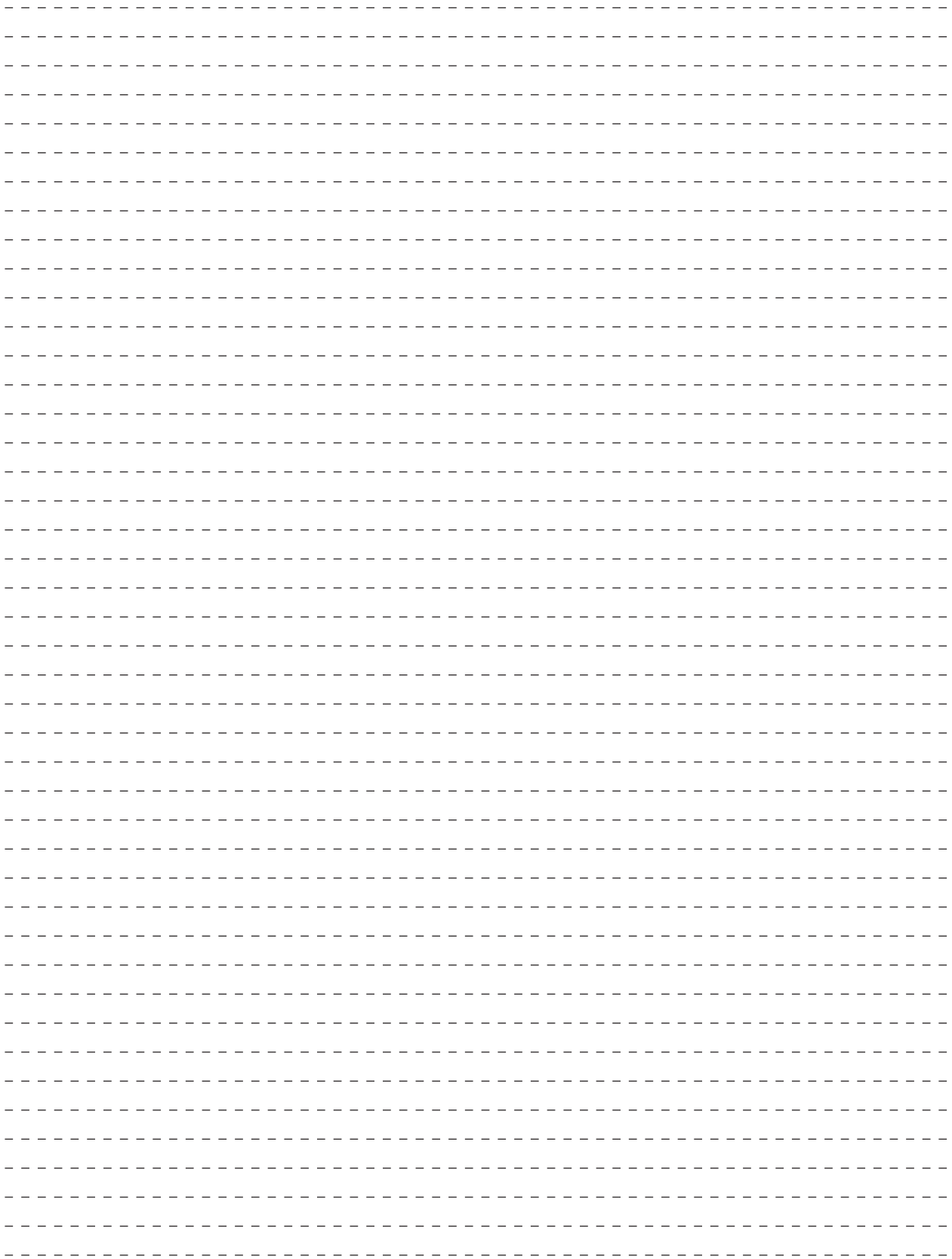

Authorized Service Centers

QUALITY **JVC**[®] SERVICE

HOW TO LOCATE YOUR JVC SERVICE CENTER

TOLL FREE: 1 (800) 537-5722

<http://www.jvc.com>

Dear Customer,

In order to receive the most satisfaction from your purchase, please read the instruction booklet before operating the unit. In the event that repairs are necessary, please call 1 (800)537-5722 for your nearest authorized servicer or visit our website at **www.JVC.com**

Remember to retain your Bill of Sale for Warranty Service.

Do not service the television yourself

Caution

To prevent electrical shock, do not open the cabinet. There are no user serviceable parts inside.

Please refer to qualified service personnel for repairs.

Accessories

To purchase accessories for your JVC product, please call toll free: 1 (800)882-2345 or on the web at **www.JVC.com**

